

# All About Fittings

Now Including  
Information on  
UHPLC Fittings  
& Connections



A practical guide to using  
and understanding fittings  
in a laboratory environment

Copyright © 2003 by John W. Batts, IV

All rights reserved.

Reproduction or translation of any part of this book without the written permission of the copyright owner is unlawful. Contact IDEX Health & Science for permission [www.idex-hs.com](http://www.idex-hs.com)

Printed in the United States of America

First printing, July 2003  
Second printing, August 2004  
Third printing, March 2011

**The following Trademarks  
and Registered Trademarks  
are found in this book:**

**Upchurch Scientific®** is a Registered Trademark  
of IDEX Health & Science LLC

**Delrin®** is Registered Trademarks  
of E.I. du Pont de Nemours and Company

**PEEK™** polymer is a Trademark  
of Victrex, plc.

**NanoPort™** is a Trademark  
of IDEX Health & Science LLC

**Halar®** is a Registered Trademark  
of Solvay Solexis S.p.A.

**Radel®** is a Registered Trademark  
of BP Amoco Polymers

**Ultem®** is a Registered Trademark  
of General Electric Corporation

# All About Fittings

## Table of Contents

- 2**    **Preface**
- 3**    **Foreword**
- 4**    **Introduction**
- 6**    **Just What ARE Fittings?**  
*the vital role fittings play in laboratory instruments*
- 16**    **How Do Fittings Work?**  
*basics about fittings most classes won't teach*
- 24**    **What Fitting Do I Have?**  
*the quick way to identify what fittings you're using*
- 28**    **Plastic or Metallic — Which Do I Choose?**  
*what's the best fitting choice? we'll talk about it...*
- 32**    **What Is HPLC?**  
*since we're talking about it so much...*
- 40**    **Other Popular "Apps"...**  
*tips for making great connections in  
microscale liquid chromatography and UHPLC*
- 49**    **A Few Extra Tips**  
*other useful hints for making great connections*
- 54**    **Appendix**  
*useful "extras" you might need to know*

# Preface

I'm very excited about this new edition of the **All About Fittings** booklet! From my first dealings with Paul Upchurch in the 1980s to the my interactions with the present-day staff at IDEX Health & Science, I've always been impressed with the level of technical know-how that is contained within this company. Although many companies have technical expertise, few share it as effectively as is done in this little publication. Not only is the technical content high, but it also is fun to read – a somewhat rare combination in today's HPLC literature.

HPLC fittings, tubing, and related products often get overlooked in discussions of HPLC equipment. However, these parts are critical if you want to obtain the optimum performance of your system. Problems are magnified as we progress to

columns with smaller particles that generate narrower peaks – a poorly assembled fitting can compromise an otherwise excellent separation. The explanations and directions contained here will help you understand what is – and isn't – important when you connect different pieces of your HPLC system. Things like thread pitch and ferrule geometry seem a bit esoteric, but you'd better pick the right parts ... or you'll be sorry!

So take a few minutes right now and familiarize yourself with the contents of the book – 10 minutes of leafing through the pages will make you familiar with the highlights. Then you'll know where to look when you have a question about fittings. Even if you're an old pro, you'll learn something useful if you read this booklet from cover to cover – I certainly did.

**John W. Dolan, Ph.D.** *LC Troubleshooting Editor, LC/GC Magazine*

# All About Fittings

Despite the large investment of time and money spent on lab equipment — and the education to know what to do with it — very little attention is given to understanding how to make great connections with fittings.

Several years ago, in an effort to address some of the more common emerging trends in analytical instrumentation, the original *All About Fittings* guide was produced. Since that time, techniques in analytical chemistry have continued to evolve, with system pressures in UHPLC becoming the new standard that accessories must withstand and with micro- and nano-flow applications helping to set a new standard for flow rates. Additionally, there has been increased emphasis on IVD and other life-science techniques.

This booklet provides essential information often required to identify the correct style and type of fitting needed for most laboratory applications. It includes more in-depth information on making great connections in UHPLC and micro- and nanoscale applications, as well as offering helpful hints for lower pressure applications, too.

If you have any suggestions for future editions, or need some additional help in identifying the fitting you need, please feel free to contact us at any time.

Happy Connecting!

**John W. Batts, IV** *IDEX Health & Science*

# Foreword

# Introduction

Welcome to ***All About Fittings!*** You are about to embark on an exciting journey designed to help you grasp the fundamentals of equipment fittings and accessories, as well as some basics about liquid chromatography as an analytical technique.

You have most likely been introduced to some of the topics covered in this manual. We've found, though, that a lot of the fundamental information about fittings and making good

connections isn't generally known... often because the information isn't covered in most college-level classes.

To make matters worse, most fittings and accessories-manufacturing companies have a vocabulary and "lingo" all their own — often consisting of engineering terms, mathematical measurements, and a large array of material names... and they expect you to understand their terminology.

## That's what this book will help you do!

We've built into this handbook information on fittings basics: how to describe a fitting, how to determine where in your system certain styles of fittings are used, the interchangeability of different types of fittings — among many other topics. We've even built in a discussion on the special terminology and skill set needed to

work with hyphenated chromatography systems, such as LC-MS and even UHPLC systems.

Through this booklet, you will gain the confidence you need to know exactly what fitting you need in almost any laboratory application!

# All About Fittings

## Icons

The Icons below are found in the page margins throughout this booklet to highlight extra-important information you'll need to know:



KEY CONCEPT

### Key Concept

Pay extra close attention...the concept covered is important to understand!



HELP ME!

### Help Me!

Highlights information that helps explain a topic or make something easier to understand.



THIS OR THAT?

### This or That?

Draws your attention to extra details you may need when deciding what product to use or where to use a product.

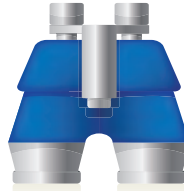

POINT OF INTEREST

### Point of Interest

Indicates there's something so interesting that it needs a second look.



SECRET REVEALED

### Secret Revealed

Used whenever a "secret" is revealed—something to help make your life easier or help make something more understandable.

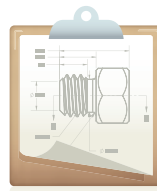

HOW IT'S MADE

### How It's Made

Offers details about how current equipment is configured, to help make product selection a little easier.



PARDON MOI?

### Pardon Moi?

Denotes those frequently-asked questions that puzzle scientists around the world!

# Just What ARE Fittings?



PARDON MOI?

That's one of the most popular questions never asked! In fact, it's not usually until your system breaks down that you even realize all the places where fittings are used!

### So...just what are fittings anyway?

According to the dictionary, a fitting is...

*...a small part used to join, adjust, or adapt other parts, as in a system of pipes*

In other words, anywhere you need to attach, adapt, or adjust piping — or tubing, in this case — there's typically a fitting involved!

In fact, all kinds of fittings are used in a standard laboratory system: flanged and flangeless; metallic and non-metallic; high-pressure and low-pressure; flat-bottomed and coned; internal and external; wrench-tightened and finger-tightened.

As Paul Upchurch stated in his book entitled *HPLC Fittings*:



KEY CONCEPT

*“...every chromatographer knows, in order to use any HPLC system, you spend a lot of time working with fittings. You must become knowledgeable with the plumbing of an HPLC system in order to do any practical HPLC work.”*

Because fittings impact almost everything you do with your equipment, one of the best investments you can make with your time is to better understand fittings and how to use them properly.

# All About Fittings

## So, let's talk about some basics...

Actually, what we commonly call a "fitting" in the analytical instrument world really refers to a **system** comprised of a **nut** and a **ferrule** (pronounced "FAIR-ruhl").



KEY CONCEPT

Ultimately, the choice of which nut and which ferrule to use in your system will be dependent upon a number of parameters:

- ▶ Threads of the receiving port
- ▶ Geometry of the receiving port
- ▶ Size and type of tubing used
- ▶ Material from which the port is made
- ▶ Amount of pressure expected

...and several others. Given the number of factors influencing the fitting choice for a given application, let's see if we can shed some light on the subject of making good connections.

## Aww, nuts!

The first of the two major components in a fitting system is called a nut. The nut is responsible for providing the driving force that causes the ferrule to seal.

There are several characteristics that are used to distinguish different nuts from each other. One of the most obvious is the head geometry (e.g., knurled, hexagonal, square, winged). But perhaps the most important feature of nuts is the threaded portion, which allows nuts to mate with their receiving ports. Let's discuss each of these in further detail to help distinguish what products you might be using, as well as what other products are available.

## Threads

Most nuts have "external threads," meaning that the threads are on the outside of the nut.

Some nuts, however, have "internal threads," where the threads are on the inside of the nut – commonly referred to as a "cap nut" or "female nut." (See Figure 1 on page 8)



THIS OR THAT?

# Just What ARE Fittings?

Because most nuts have external threads, let's focus on this nut geometry...

In order to describe a thread on a fitting, something called a "thread call-out" is used, consisting of two main numbers.. The first number tells you about the diameter of the thread, and the second number describes how close together the threads are. Here's an easy example:

One of the most widely used threads in low-pressure fluid transfer is 1/4-28. Notice the two numbers here, separated by a hyphen. Now, let's apply the description above and see if we can determine some basic information about this type of thread.

The first number in the thread call-out is "1/4". Since we know this number tells us about the diameter of



the threads, we have our first clue. In this case, the call-out unit of measurement is inches, so this denotes a thread diameter of one-quarter of an inch! The diameter of the thread is measured from the crest of a thread all the way across to the opposite crest. In other words, we're identifying the maximum diameter of the thread.

The other number in the thread notation is not so obvious. What do you think it means? Remember, the number tells how close together the threads are.

Any ideas? Well, if you thought that it means there are 28 threads on the fitting, you would be in good company...but unfortunately that's not the right answer. What the number tells you, in this case, is how many threads per inch there are on the nut. (For more information on how to measure these critical dimensions on any fitting you have, see page 24 of this guide for an in-depth discussion on determining the thread call-out of your fitting.)

**FIGURE 1** Threaded Nuts

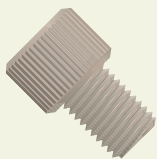

Externally-Threaded Nut



Internally-Threaded Nut

# All About Fittings

## Why not just tell you how many threads are on the nut?

Simply because it's not nearly as universal. Every time the length of the nut changed, the thread specification would also have to change, and that would make it very difficult to standardize. However, if the thread is measured in something like "threads per inch," then it doesn't matter if the nut is 1/2" long or 5 feet long...it still has the same "name!"



PARDON MOI?

Let's look at another thread option — the "workhorse" of higher pressure chromatography applications: the 10-32 thread. What does this thread call-out tell us?

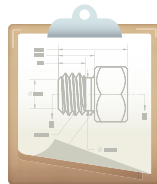

HOW IT'S MADE

Again, we know the first number tells us something about the diameter of the thread. Yet, in this case, it doesn't mean you have a 10 inch diameter thread!

In the "fittings world," when an English thread goes below 1/4" in diameter, then gauge numbers are typically used when referring to the thread diameter. Therefore, the "10" in the call-out refers to a gauge 10 — which translates to almost exactly 3/16". In microscale and nanoscale applications, a gauge 6 thread is commonly used. This thread gauge is almost exactly 3.5 mm or approximately 9/64" in diameter.



SECRET REVEALED

For more information on various thread diameters and pitches, see the chart on page 25, and for more information on making good capillary connections, see page 41.

But what about the "32"? As with the 1/4-28 example, this number means *thirty-two threads per inch*.

So, if you compare a 10-32 threaded fitting with a 1/4-28 threaded fitting, which would you expect to have threads closer together? It would be the 10-32 thread, since it has more "threads per inch" or a finer *thread pitch*.

## FOOD FOR THOUGHT...

Why are 10-32 threaded nuts used in most high pressure applications instead of 1/4-28 threaded nuts? One reason is that denser threads means that there's more threads to "share the load" and resist the pressure generated inside the receiving port.

## Just What ARE Fittings?

You may have noticed that the term “English thread” was mentioned a little earlier. That’s to help identify that the thread call-out follows the traditional English system, using “inch” as the common unit of measurement. It also helps distinguish nuts using this system from those using the metric system, which is also used in chromatography equipment connections but uses “millimeter” as the unit of measurement.

The most common metric thread used in laboratory equipment is M6 x 1 (although you will often only see M6 listed). Let’s try to apply the same principles we learned with the English-threaded fittings to these metric fittings.

First, remember that the first number refers to the diameter of the threads, and since this is a metric fitting, the diameter is 6 millimeters!

The “1” portion of the thread name designates the distance between adjacent threads!

Therefore, this thread has **1 millimeter**

**between each thread** — the inverse of how an English thread is measured. While an English thread (such as the 10-32 and 1/4-28 we’ve already discussed) measures the number of threads per inch, a metric thread measures the number of millimeters per thread.

Even with the differences between the two systems, tremendous similarities exist, and by studying this information, you should better understand how and why threads are named the way they are!



## Let’s Test Your Knowledge...

Now that you’ve learned what the names of threads mean, let’s apply that to another thread.

**The thread is...5/16-24.**

- ▶ What is the diameter of this thread?
- ▶ What is the thread pitch?
- ▶ Based upon this thread pitch, how many threads exist in 1/4”?

To see if you’re right, check the answer at the bottom of this page!

The diameter of the thread is 5/16”, and the thread pitch is 24 threads per inch. In 1/4” there are 6 threads (24 threads/inch x 1/4” = 6 threads).

# All About Fittings

## Head Geometry

Fittings are described by more than just their threads, as we've discussed. Another major factor that helps determine what nut to use is the geometry of the head.



Many nuts can only be properly tightened with a wrench. So, for those nuts, it's important to note if they have a "hex-head" or "wrench-flat" geometry, and then to specify what the diameter is from flat side to flat side. This tells you what wrench you need to use.

Other nuts, however, can be tightened without a wrench; all you typically need are your fingers to tighten them properly! Rather than using a "hex head" or "wrench flat" geometry that is difficult to tighten by hand, these "fingertight" fittings often feature a "knurled" head...and sometimes are even enhanced with "wings" — to offer more gripping surface and extra friction against your fingers. *Note: In microscale applications, where the fittings are often smaller than standard fittings, it is common to find the heads of these fittings designed with a "micro-knurl" pattern. However, because of their overall diameter, these fittings still typically require the use of custom-designed tools to ensure they are tightened sufficiently to hold tubing*

FIGURE 2



Hex-Head



Wrench Flat



Knurl



Winged Head

to their stated pressure limits. Be sure to consult with the fittings supplier for more information on proper tightening of these smaller fittings.

## Other Items

Besides the thread size and head geometry, there are other factors that influence what nut you need to use.



THIS OR THAT?

One thing to consider is the overall length of the nut. Long nuts are great for use in angled ports, to increase the gap between adjacent fittings. But long nuts may be difficult to use in some "space-challenged" ports. So, for those ports, shorter nuts are in order.

You should also consider the dimensions of the tubing you are using, as most nuts have a specific-

# Just What ARE Fittings?

sized hole passing through them (called a “thru-hole”) which frequently corresponds to a tubing’s outer diameter. Therefore, when choosing the nut for your fitting system, you will often need to reference your tubing’s outer diameter.

Another major distinguishing factor between fittings is the material that has been used to manufacture the nut. Originally, this wasn’t important, as most nuts were made from stainless steel. However, as fittings technology has advanced, polymer-based nuts have been developed.. Materials like Delrin®, PFA, ETFE, polypropylene, PCTFE, PEEK™, and PPS are all options, and with each new material comes new advantages and disadvantages to consider (e.g. chemical compatibility, thread strength...even color!). Refer to the Polymer Reference Chart and other resources in the Appendix, or check with your favorite fittings supplier for assistance in choosing the best fitting for your application.

**FIGURE 3** Various Ferrules



## Ferrules

Now that you’ve absorbed all this “nut knowledge,” don’t forget this is only half of the fittings story.

In fact, the nut isn’t really the “business end” of a fitting system...it’s the ferrule that’s doing most of the work!

Most standard laboratory fitting systems work through external compression (or “gripping”) onto the tubing’s outer wall. And, while the nut provides the driving force for compression, it’s the ferrule that compresses against the tubing and thus holds the tubing in place.



KEY CONCEPT

Ferrules aren’t nearly as complicated as their nut counterparts, but they do have some distinguishing features to help you determine which ones to use.

## What They Look Like

While ferrules come in all shapes and sizes (see Figure 3), one thing they have in common is their tapered noses... and it’s at the end of this nose where ferrules do what they were designed to do — grip the tubing wall!



SECRET REVEALED

# All About Fittings

However, that doesn't mean ferrules are all interchangeable! Things like tubing size, pressure requirements, mating nuts, and — most importantly — the geometry of the receiving port must all be considered when choosing the right ferrule for any given application.

## Where They Are Used

From our discussion earlier, threaded ports can be classified as “high pressure” and “low pressure.” While the definition of “high” and “low” is often different depending on whom you ask, one distinguishing feature is the geometry of the receiving port (see Figure 4).

Generally, low pressure receiving ports end in a flat-bottom configuration. In other words, as the threads run out, the bottom of the port becomes flat across the entire port diameter, with a small “thru-hole” in the center of the flat bottom. The ferrules used with this type of port will typically have their tapered noses facing toward the nut and away from the flat bottom of the receiving port. In these fitting systems, the threaded barrel of the nut will

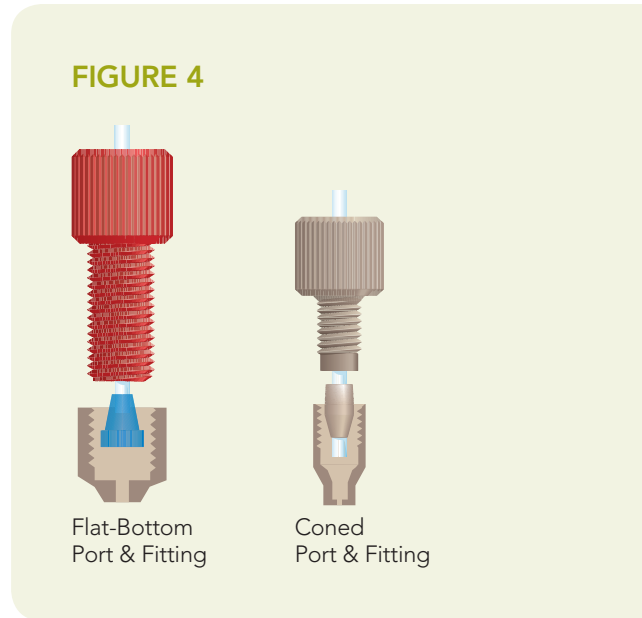

often feature an internally tapered surface, designed to interface with the tapered nose of the ferrule and help create a seal against the tubing wall. (For more information on low pressure fittings, please see the discussion on page 22.)

High pressure receiving ports, on the other hand, have an internal taper just past the threaded portion of the port. Then, just beyond the internal taper is a small pocket — often called the “tubing pocket” — which is nearly the same diameter as the tubing that extends into it. In these types of ports, the tapered nose of the ferrule faces away from the nut and toward the port.

## A Little Ferrule Ditty

“Tapered noses face the port  
When pressures are high  
But they face the nut  
When low pressures apply!”

# Just What ARE Fittings?

## Manufacturing Material

One very important characteristic of any ferrule is the material from which it is made.

Ferrules are often manufactured from materials such as stainless steel, PEEK™, ETFE, polypropylene and PCTFE. Materials such as PEEK polymer (a beige-colored plastic), PCTFE, and stainless steel are often used to manufacture ferrules for high pressure applications. Softer polymers, including ETFE and polypropylene, are used primarily (although not solely) in lower-pressure applications.

## Other Factors

Making great connections is impacted by more than just the fitting itself. Other things to consider include the following:

**Tubing:** There are two primary features of your tubing that can have a dramatic impact on the quality of the connection you are making. First, it's important to know what the material is from which the tubing has been manufactured. Some materials — like FEP and PFA — offer optimal resistance across a broad spectrum of chemical solutions; however, the “trade-off” is often in pressure resistance. Other materials like PEEK and stainless steel offer excellent pressure resistance but are not as chemically inert as some of the softer fluoropolymer options. Knowing

the material will help you determine if the tubing you have chosen will work in the connection you are trying to make.

Because most fittings systems grip the outside wall of the tubing, knowing the outer diameter of your tubing is important. This information both helps you select the right fittings to use as well as helps ensure the tubing will fit properly into the receiving port.

**Receiving Port:** Especially in higher pressure areas of your system where coned ports are most typically found, knowing what the material is from which the receiving port has been designed will help you determine if you can use the fitting you have chosen in that receiving port. A great rule of thumb is that the receiving port should be manufactured from a material that is at least as hard as the material from which the fitting has been manufactured. Additionally, coned ports feature a “tubing pocket” with a diameter that is designed to be paired with a specific tubing outer diameter. This is particularly important to note when making capillary tubing connections, as the tubing is often of a different size than the receiving port is designed to accept, requiring special accommodations to ensure a good connection is made. (For more information on making capillary tubing connections, see the section titled “Making Capillary Tubing Connections” on page 41.)

# All About Fittings

## Together at last!

As you might've guessed, both the nut and the ferrule are important components of a fittings system, a matched set designed to work together!



KEY CONCEPT

In any connection system, you cannot expect to use just the nut alone, as nothing would be present to grip the tubing, and the ferrule cannot grip the tubing wall without the driving force of the nut. The entire system must work together to provide you with a consistent hold and seal on the outside of the tubing wall.

**...Which Leads Us To Our Next Chapter**

**In some polymer fittings systems, the nut and ferrule are together as a single piece. These one-piece fittings systems still have all the same features as other multi-component systems; however, by combining the components, a one-piece fittings system is usually more convenient and easier to use.**

# How Do Fittings Work?

We've taken some time to learn some basics about fittings, and we've even gone over some new vocabulary. Now, let's see if we can figure out how they actually work.

But first, we need to lay some groundwork. Whenever we talk about "fittings" from now on, we'll most often be referring to the combined nut and ferrule system. (Be aware that some fittings have both the nut and the ferrule together as one piece, as mentioned on the previous page.)

## Now, let's dig in!

To understand how fittings work, it's important to know what fittings have to DO.



KEY CONCEPT

Specifically, fittings have two primary functions:

▶ Preventing liquid (or gas) from leaking out of the flow path

▶ Holding tubing in place against opposing pressure

These jobs may sound somewhat mundane; however, when you consider the nature of the chemicals that often travel along a given flow path, coupled with the high pressures that often exist inline, you may begin to realize just what a difficult job fittings have!

## So, how do fittings do what they have to do?

Most laboratory equipment fittings generally work through a process called *external compression*.

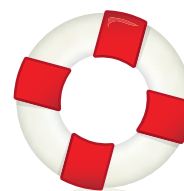

HELP ME!

In other words, as a fitting holds a piece of tubing in place, it compresses the outside (or external) wall of the tubing. Depending on the material used to make the fitting, this external compression either becomes permanent, through a process called *swaging*, or remains temporary, holding the tubing using simple friction against the tubing wall.

# All About Fittings

So, what drives this compression? It has to do with a concept called “interfering angles.” This gets a bit more technical, so let’s delve deeper to gain a better understanding.



We already discussed how ferrules are most often tapered on at least one end, and how the orientation of the ferrule usually depends on the pressure you expect the fitting to withstand (and the internal geometry of the receiving port, of course!). Generally, the primary tapered portion of any ferrule (or fitting, if it is a one-piece style) will face the portion of the port that is also tapered, resulting in a connection that has two angled surfaces coming together (see Figure 5).

Let’s look at the three possible outcomes when these two angled surfaces come together:

## 1. Ferrule has a wider angle than the receiving port

In this scenario, as the fitting tightens into place, the tip of the ferrule’s tapered nose doesn’t actually make contact with the receiving taper at all; rather, contact occurs partially up the ferrule’s wall. This scenario creates ineffective compression of the ferrule’s tapered nose on the tubing wall and may result in a leaking connection or a lack of ferrule “holding power.”

## 2. Ferrule and receiving port have identical angles

In this example, because the angles match, the ferrule’s entire tapered nose makes contact with the receiving port at the same time. And, no

**FIGURE 5** Ferrule Orientation

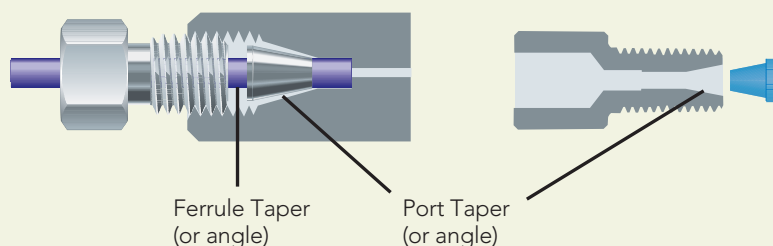

# How Do Fittings Work?

matter how much you tighten the accompanying nut, the two mating surfaces are simply wedged more tightly into place, resulting in virtually no compression on the tubing wall. Again, this would typically produce a leaking connection.

### 3. Ferrule has a narrower angle than the receiving port

Here, the tip of the ferrule makes contact with the receiving port first, and as the fitting is tightened into place, the ferrule begins to conform to the port's angle, and compresses against the tubing wall. Just what you want!



(Figure 6 illustrates each of these scenarios.)

Besides the seal and grip created around the outside tubing wall, you also need a seal between the outside surface of the ferrule and the internal surface of the receiving port. The quality of the seal really depends on the surface quality of both the receiving port and the ferrule. Any imperfections on either surface may cause a leak.

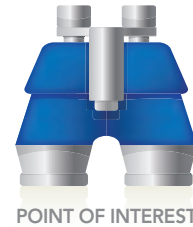

**FIGURE 6** Three Ferrule Interfaces

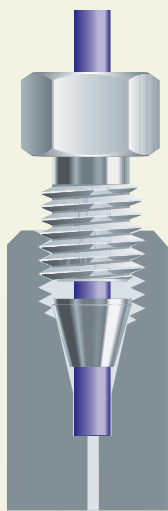

Ferrule Wider Than The Port

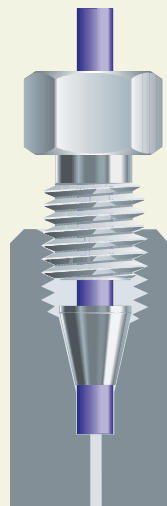

Ferrule Same As The Port

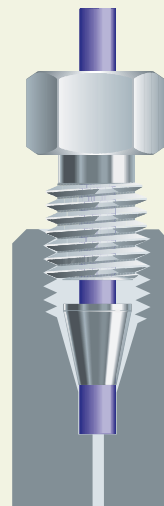

Ferrule More Narrow Than The Port

# All About Fittings

## High pressure connections

The most demanding fluid connections are typically found in the high pressure areas of a system — in fact, it's not unusual for pressures in HPLC to reach and exceed 4,000 psi (276 bar) and in UHPLC to reach pressures of 15,000 psi (1,034 bar) and higher! Because these connections experience the largest amount of stress, let's focus first on how to make good high pressure connections.

One of the most popular styles of connections used for HPLC and UHPLC high pressure fluid pathways is a "swaged" connection.

We briefly mentioned the concept of swaging earlier. Now, let's look at the process of swaging a little more closely — what it is, how it works, and why it remains so popular today.

First, as a recap, swaging means "permanently" attaching a ferrule to a piece of tubing, typically in a high pressure application. Often, both the fitting and the tubing are manufactured from some form of stainless steel, although that doesn't always have to be the case. However, swaging typically will not involve an all-polymer ferrule. Most people who are swaging are using stainless steel ferrules as part of the fitting system.

In order to swage a ferrule onto a piece of tubing, slip the nut over the tubing being connected. Follow that by slipping the ferrule over the tubing, just below the nut, ensuring the tapered nose of the ferrule is facing away from the nut (remember the little poem from page 13?).



Once the nut and ferrule are in place, insert the tubing into the receiving port until the tubing butts up against the bottom of the port. *Please Note: This process works for most ports; however, some ports do not have a solid stop against which the tubing can rest. For these, extra care is necessary to ensure the tubing remains extended past the ferrule's nose...but not too far!*

With the tubing held in place, finger-tighten the nut completely, and then wrench-tighten it another 3/4 turn. This often will complete the swage, crimping the ferrule onto the surface of the tubing. To make sure this has been done correctly, loosen the assembly and remove it from the receiving port. Inspect the ferrule to ensure it will not come off; if it's still loose, reinsert the fitting and tubing assembly into the receiving port and

## How Do Fittings Work?

tighten in 1/4-turn increments, checking to see if the ferrule has been fixed onto the tubing after each 1/4-turn.

*Please Note: The tightening recommendations listed above are intended for use with traditional HPLC and related equipment. If you are using UHPLC systems or working at ultra-high pressures, additional tightening may be required to achieve the pressure holding ability you need.*

### FOOD FOR THOUGHT...

Swaged fittings offer some significant advantages. One is that they permanently attach to the wall of the tubing. This allows swaged fittings to hold to high pressures — almost always well above the pressure rating of the equipment into which the fitting is attached.

...NOW YOU KNOW!

**FIGURE 7** "Dimension X" from Various Manufacturers

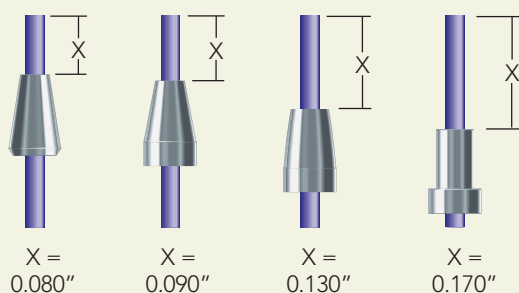

*Dimension X can range from 0.080" to 0.170" among various manufacturers*

The fact that swaged fittings are permanently attached also helps to keep the fittings with a piece of tubing. Since they're attached, they won't come off accidentally. (This is a big help if you tend to be "challenged" with small things!)

Unfortunately, this permanent attachment also becomes a major disadvantage! Why?

**Because you can only use the fitting in one port — the one into which it was swaged.**



PARDON MOI?

You see, when a fitting is swaged, there is always a length of tubing extending past the ferrule. It has to be this way, or the ferrule would have no place to "bite" down during the compression process. The complication is that every major manufacturer requires the length to be a little bit different (see Figure 7). This means that once swaged into a receiving port, for the best analysis results, a fitting should only be used *with that original port!* Attempting to use a swaged fitting with any other port may result in either dead volume (see pages 51–53 for a discussion on "dead volume") or a chemical leak — particularly when equipment from multiple manufacturers is being used!

# All About Fittings

## The problem fixer

One of the most commonly encountered problems with fittings is a chemical leak (e.g., when switching between different brands of HPLC columns). Initially, when a leak occurs, it's often best to make sure the fitting has been tightened properly. Often, though, a leaking connection is due to a problem with the positional placement of the ferrule on the tubing wall. Unfortunately, with a swaged fitting, the ferrule is permanently attached to the tubing, so it cannot be repositioned or changed (at least not without damaging the tubing and/or the ferrule). This usually results in throwing away the entire piece of tubing — with two ferrules and nuts attached — making this option very expensive.

### There IS another option...the fingertight fitting.

Fingertight fittings are typically polymer fittings that work in the same receiving ports as their all-metal counterparts. Because they are manufactured from high-end polymers rather than from materials like stainless steel, you can achieve good performance from a fingertight fitting without using any tools other than your hand. Also, because they are manufactured from polymer materials, they do not



THIS OR THAT?

permanently adhere to the surface of your flow path tubing, which allows them to be repositioned as needed to help avoid leaking connections and dead volume.

In addition to the obvious benefits, other advantages have helped the fingertight fitting become a laboratory essential:

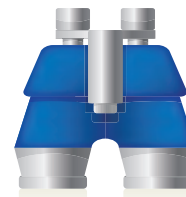

POINT OF INTEREST

### Biocompatible

Many biological samples are known to interact with iron, a chief component of stainless steel...but not a component of most polymers.

### Universal

While many customers are forced to use system-specific metal fittings, in most cases just one style of fingertight fitting can be used to make connections throughout a system.

### Interchangeable

Because fingertight fittings do not permanently attach to the tubing wall, they can often be moved from port to port while still allowing you to make a good connection by ensuring the tubing is fully inserted into the receiving port.

## How Do Fittings Work?

The use of fingertight fittings is popular in both analytical-scale applications as well as in applications involving capillary tubing. However, when fingertight fittings are used with capillary tubing, the fittings often employ special features — like custom ferrules or tubing sleeves — to help make good connections. For more information, see the discussion on capillary tubing connections beginning on page 41.

Of course, fingertight fittings are not without limitations. One limitation is directly linked to one of their primary advantages -- that they do not permanently attach to tubing walls. While this is advantageous for repositioning connections and overall interchangeability, it does mean that fingertight fittings often have a lower-pressure holding ability than

comparable swaged fittings. Other limitations can be linked to their performance in elevated temperature applications and even linked to chemical interaction in some rare cases. Nonetheless, fingertight fittings typically offer substantial benefits that far surpass their limitations... which is why they have been so widely adopted around the world!

### What About Low Pressure Connections?

Of course, not all fluid connections in your system are high-pressure connections — in fact, most of the connections are likely ones that can be considered “low-pressure” connections. Typically, the fittings used to make “low-pressure” connections are different from traditional “high-pressure” fittings.

First, most low-pressure receiving ports do not have a coned (or “tapered”) internal surface. Instead, they often transition from the internal threads of the connection directly to a flat-bottom. Of course, as you might expect, these types of ports require different fittings — fittings that are focused on making a seal on the flat-bottom feature.

The original style of low-pressure, flat-bottom fittings was the flanged fitting — a style still in use today! When a flanged fitting connection is

**FIGURE 8**  
Flanged Fitting Connection



# All About Fittings

made, the flow path tubing is flared out at the end, and the supporting fitting presses the tubing flare against the bottom of the receiving port.

Flanged fittings are still used because of their relative low cost and ease of use. However, if anything goes wrong with a flanged connection, it can be difficult to repair. Therefore, many people have migrated away from flanged tubing connections and switched to “flangeless” connections.

In a flangeless connection, rather than flare out the tubing to make a seal in the bottom of the receiving port, this system (and others similar to it) typically uses a separate fitting and an external compression ferrule. But instead of having the coned tip of the ferrule facing away from the fitting, this fitting style has the coned tip of the ferrule facing toward the fitting. (see Figure 5, page 17, for an example of a typical flangeless fitting system, shown on the right-hand side of that figure.)

Most of the time, low pressure connections do not require any tools to make good connections — simply hand-tightening is sufficient. Also, when a flangeless fitting system (or something similar) is used, low-pressure components often share many of the benefits of fingertight fittings, including biocompatibility, interchangeability and even universal use in most receiving ports!

**FIGURE 9** Barbed Connectors



## Barbs Away!

While many low-pressure connections use rigid or semi-rigid tubing — and can thus utilize traditional external compression fittings — there are some connections for which external compression fittings will not work. Specifically, when softer tubing is used — for example, with peristaltic pumps — external compression fittings are not usually the best option. For these applications, the most common form of connector is the “barbed” connector.

A barbed connector works by forcing softer tubing to expand over a barbed nose. This causes the tubing to “grip” the connector and remain in place. However, this connection is typically only good for low pressure applications, because as the pressure increases inside softer tubing, it causes the tubing to expand. Eventually, with enough internal pressure, the tubing will expand sufficiently to slip off the barbed connector being used.

# What Fitting Do I Have?

Once you understand how fittings work, one of the biggest frustrations can be figuring out what fitting you have, so you can replace it with a usable alternative when needed.

We've already discussed some defining characteristics for fittings, all of which will help you determine what fitting you already have... and then help you decide which fitting(s) would best suit your needs:

▶ Threads on the fitting

▶ Geometry of the fitting (coned or flat-bottom)

▶ Size and type of tubing being connected

▶ Material from which the fitting is manufactured

▶ Amount of pressure expected

## A Thread By Any Other Name...

We talked earlier about the thread on a fitting, and what that thread call-out tells you specifically. Reviewing, each thread call-out usually consists of two main numbers — both telling you something about the thread. For instance, looking at a thread call-out such as 1/4-28, the "1/4" reference indicates the thread has a maximum diameter of 1/4", and the "28" tells us how many threads per inch exist along the shaft of the fitting.

But, how do you tell what type of fitting you have? If you don't have any information about the fitting, then determining its thread description is one of the most critical pieces of information you can obtain.



Fortunately, you can usually determine what thread you have with a common ruler and a good eye. First, line up the threaded section of your fitting against your ruler's edge, as shown in Figure 10a on the next page. It's most helpful if you use at least a 1/4" section of threads for performing this measurement.

# All About Fittings

Next, count the number of threads along the barrel of the fitting, until you get to the 1/4" mark on your ruler.

**REMEMBER: THE FIRST  
THREAD IS YOUR ZERO MARK...  
DON'T INCLUDE IT IN  
YOUR THREAD COUNT!**

If you have an English thread, one of the threads on your fitting should line up with the 1/4" mark (In Figure 10a, there are 7 threads in 1/4"). Then, all you have to do is multiply your result by four to get the number of threads per inch — otherwise known as the **thread pitch!** (If you have a metric thread, then this won't work! We'll go through that in a moment...).

Once you determine the number of threads per inch on your fitting, the diameter of the threaded portion is much easier. Simply place the threaded barrel of your fitting on top of a ruler and measure the widest distance, from the thread crests on one side of the nut to the thread crests on the other side of the nut, as illustrated in Figure 10b, right, where this distance is 1/4".

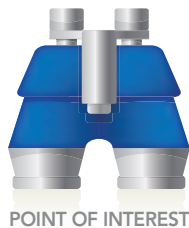

**FIGURE 10A**

Counting Your Threads

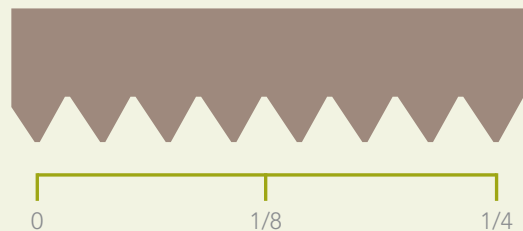

**FIGURE 10B**

Thread Diameter

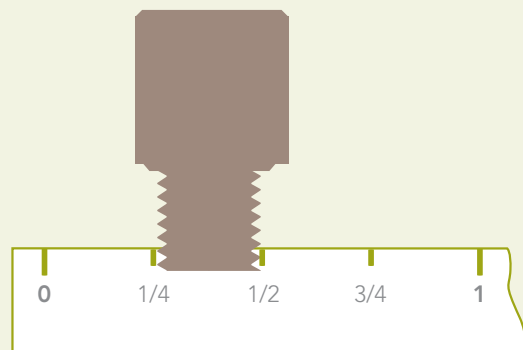

## What Fitting Do I Have?

For most English threaded fittings used in chromatography, the diameter often corresponds with the thread pitch according to this chart:

| Threads Per Inch | Diameter                           |
|------------------|------------------------------------|
| 20               | 1/2"                               |
| 24               | 5/16"                              |
| 28               | 1/4"                               |
| 32               | 3/16" (Gauge 10) & 9/64" (Gauge 6) |
| 40               | 9/64" (Gauge 6)                    |

Of course, there are variations which exist, but this chart can serve as a good starting place.

When working with metric-threaded fittings, manual measurement is somewhat different but uses the same concepts.

Remember that the most common metric-threaded fitting used in chromatography and related applications has the designation "M6." Technically, this is incomplete; the real designation for the thread is M6 x 1. If you'll recall, this means that the thread has a six millimeter diameter (the "M6" part), and has a thread pitch of one millimeter per thread (the "x 1" part). Notice this is inverse from English threads, which tell you



how many threads per inch. (See page 10 for more information.)

To measure the thread pitch of a metric-threaded fitting, hold the threaded barrel of your fitting against a ruler with millimeter increments. Line up the crest of a thread near the head of the fitting with one of the millimeter markings on the ruler. Then, examine where the rest of the thread crests fall. The most commonly used metric threads will have each thread crest line up EXACTLY with each millimeter mark on your ruler. Other metric-threaded fittings may not have their threads spaced one millimeter apart; however, they will follow a pattern (like ten threads in seven millimeters, for instance — used for a M4 x 0.7 thread).

To measure the diameter of your metric-threaded fitting, use the same method described for English threaded fittings, only using the metric side of your ruler as a reference point.

# All About Fittings

## In case you want it easy...

Now that you've gone through the thread-measuring exercise, you can use the diagrams in the chart below to help you more easily determine the threading of your fitting.

To use this resource, simply hold your fitting over each of the silhouettes

to see if your fitting matches any of them.

Each shadow drawing is an exact replica of the thread given; therefore, the diagrams can be used either to quickly verify a thread or as a check against your measurements.



## What threads do I have?

Hold your fitting over the thread silhouettes below to identify the threads.

### U.S. Customary Threads

6-40



6-32



10-32



1/4-28



5/16-24



1/2-20



### Metric Threads

M4 x 0.7



M6 x 1



# Plastic or Metallic — Which Do I Choose?

One of the most common dilemmas a fittings user faces is deciding between plastic and metallic fittings. These and many other questions are often asked:

- ▶ **My system already uses stainless steel fittings, so I have to keep using them...right?**
- ▶ **Will my chemicals or my sample interact with the fitting?**
- ▶ **If I'm using metal tubing, I can't use plastic nuts and ferrules...can I?**
- ▶ **Which type of fitting will actually hold up to the pressure I need?**

Here, we'll address the most common questions and concerns.

### Can I Really Change My Fittings?

It's common to think that you need to use the same type of fitting originally included with your instruments. In fact, this is one of the main reasons stainless steel fittings have remained as popular as they are!

Fortunately, instrument performance is rarely linked to one specific fitting, which offers you the freedom to change your fittings to best suit your application and needs. To help choose the best fitting for your application, first consider what the fitting is supposed to do. Does it hold high pressure or low pressure? What is the chemical environment? What is

the operating temperature?

One other factor to consider when deciding what fitting to use is *how* the fitting will be used. If you plan to connect a piece of tubing to a receiving port and rarely take it out, then a stainless steel fitting is often a good option. However, if you expect to make frequent connections with the fitting, or if you plan to use the tubing in multiple locations (for instance, with multiple columns in your HPLC system), a polymer fitting is really the best option.

After answering these questions, look

# All About Fittings

for the fitting system that offers the combination of good performance and overall design features that make it easy to use, reliable, and the best “fit” for your application.

Keep in mind that while there are some applications where metallic fittings make useful connections, polymer fittings are often an excellent choice in most applications, regardless

of what kind of tubing is being used. Ironically, the opposite does not hold true — stainless steel fittings cannot be used in many places where polymer fittings are being employed... specifically in those applications where a polymer fitting is attaching tubing to a plastic port. In those applications, using a stainless steel fitting will likely cause damage to the receiving port!

## What About The Chemical Environment?

This is a very valid question, and one that must be considered regardless of what type of fitting you choose. If incompatible chemicals contact a fitting, its ability to seal and its thread integrity may be compromised.

application where a low concentration of TFA (trifluoroacetic acid) is being used. In this type of application, the PEEK ferrule will perform adequately. However, if the solution comes in prolonged contact with the nut (e.g., if some of the chemical solution got on the port’s threads when the fitting was previously loosened), eventually the polymer would erode away at the point of contact. The fitting’s integrity would then be compromised — resulting in a leak!

### A Good Rule to Follow:

**ALWAYS CONSIDER THE CHEMICAL ENVIRONMENT!**

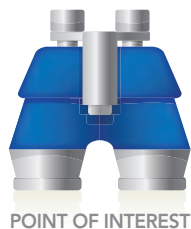

Additionally, since most fittings comprise two pieces — the nut and the ferrule — you should consider chemical compatibility with both the nut and the ferrule material. For example, you may have a fingertight fitting with a PEEK™ polymer ferrule and a Delrin® nut, and you need to make a tubing connection in a LC-MS

There are many sources for up-to-date information regarding chemical compatibility (a summary of chemical compatibility information is provided in the Appendix of this booklet on page 61), including the manufacturer of the fittings you have chosen to use. Other sources are also available on the internet. We highly recommend you refer to one of these sources before finalizing your fittings selection.

# Plastic or Metallic – Which Do I Choose?

## What Material With What Tubing?

By now you probably realize that you can nearly always use a plastic fitting on any type of tubing — polymer or metallic. As long as the fitting will hold more than the pressure you expect with your application and as long as your tubing is suited for the style of connection you are trying to make (e.g., external compression, internal expansion, etc.), then you should not have any problems with the connection.

On the other hand, it can be dangerous — or even impossible — to use a metallic fitting on plastic tubing. When a metallic fitting crimps down on plastic tubing, because the metal is so much stronger than the tubing material, it very firmly squeezes the tubing wall. In fact, it might squeeze the tubing wall so hard that it

Which to Choose  
– a poem

“Steel on plastic  
Way too drastic!  
Plastic on steel  
What a deal!”

damages the tubing or collapses the inner diameter, thus rendering your tubing unusable in your application. To help determine the possible fitting options that can be used — assuming the flow path tubing you are using is fairly rigid — you can reference the poem above and the following table as guidelines:

Table 1 — Fittings Applications

| Fitting | Tubing  | Port    | Recommended? |
|---------|---------|---------|--------------|
| Plastic | Plastic | Plastic | Yes          |
| Plastic | Steel   | Plastic | Yes          |
| Plastic | Steel   | Steel   | Yes          |
| Plastic | Plastic | Steel   | Yes          |
| Steel   | Steel   | Steel   | Yes          |
| Steel   | Plastic | Steel   | No           |
| Steel   | Plastic | Plastic | No           |
| Steel   | Steel   | Plastic | No           |

# All About Fittings

## What About The Pressure?

One of the stigmas associated with using a polymer fitting instead of a metallic one has to do with the system pressure. In fact, most metallic fittings will hold to higher pressures than their polymer fitting counterparts. Yet, the REAL question to ask is just how much pressure must the fitting withstand? If your application only calls for 1,000 pounds per square inch (psi), and you have a choice between a stainless steel fitting that holds to 10,000 psi (689 bar) and a polymer fitting that works to 6,000 psi (414 bar), it doesn't matter which fitting you choose because both will work for that application.

For super high pressure applications, such as UHPLC where system pressures can exceed 15,000 psi (1,034 bar), most analysts prefer to stick with metal nuts and ferrules or other specialized fittings designed for use with those pressures. But for low, moderate and standard high pressure applications, a polymer fitting option usually exists. Be sure to consult the manufacturer's data on a fitting's ability to hold to the pressure your application demands.

## Summing up

Overall, plastic fittings can serve as the connection of choice for a vast majority of tubing connections. The following reasons show why:



- ▶ A wide variety of polymer fittings is available
- ▶ Polymer fittings frequently offer superior chemical compatibility
- ▶ Polymer fittings can hold to most required pressures
- ▶ Nearly universal functionality is possible with polymer fittings
- ▶ Polymer fittings are reusable over and over again

## The bottom line

---

Polymer fittings are often superior to similar ones made of stainless steel or other metals.

# What is HPLC?

One of the main liquid transfer applications using the fittings we've discussed is HPLC. Because it is such a popular analysis technique, it seems appropriate to invest some time discussing it.

HPLC is an acronym that stands for High Performance Liquid Chromatography. (Many people think the "P" stands for "Pressure," as the operating pressures for many HPLC applications is quite high; however, the "P" really does stand for "Performance.")

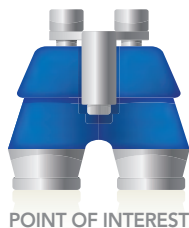

HPLC began to be used in the 1960's. The technique allows analysts to separate a sample of known or unknown composition into its components, and then to quantify how much of each component is present in the sample. And, because this technique is generally non-destructive, HPLC is a very useful tool in the laboratory, as it allows the scientist to continue performing other tests on his or her sample after it has been analyzed using an HPLC system.

Separation occurs by introducing a sample into a liquid chemical stream known as the **mobile phase**, which in turn carries the



KEY CONCEPT

sample to a specialized tube called the **column** packed with small, chemically-active particles known as the **stationary phase**. Inside the column, the sample interacts with both the mobile phase and the stationary phase and begins to chemically separate into its components. Other equipment in the system create and collect data from the analysis of those separated sample components. Those data are then summarized in a printed graphical plot called a **chromatogram**. (WHEW!)

# All About Fittings

## What makes up an HPLC system?

Before we can go any further, it is important to understand what components are part of a standard HPLC system.

An HPLC system includes seven basic components, each with a vital function:

**Solvent reservoir:** The solvent reservoir holds the chemical solution that moves through the system. Because this solution is moving throughout the analysis, it is called the mobile phase.

**Pump:** The pump pulls the mobile phase out of the reservoir and pushes it out through the rest of the system. The most common pump in use today is the dual-piston pump — capable of delivering stable flow rates at high pressures.

**Injection valve:** The injection valve introduces the sample into the mobile phase. The most common injection valve is a six-port, two-position valve (see Figure 11). This type of valve allows a controlled amount of sample to be reproducibly introduced into the mobile phase pathway with little or no disturbance to the rest of the system.

**FIGURE 11**

Typical Injection Valve Plumbing  
*Viewpoint From Rotary Knob*

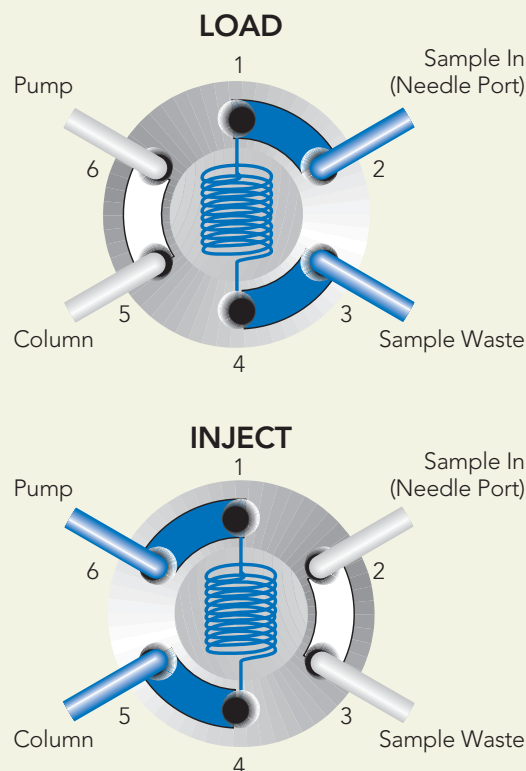

## What is HPLC?

The invention of the injection valve truly revolutionized chromatography, as it automated the way for samples to be introduced and analyzed.

What originally began as an analysis technique with the capacity of working with 20-40 samples per day, HPLC systems (when coupled with the proper equipment) can handle hundreds of samples per day, allowing for rapid drug discovery as well as high throughput genomics and proteomics work.

**Column:** Often called the heart of the HPLC system, think of the column as a chemical “filter,” of sorts. The column is a tube of some specified length and inner diameter and usually filled with small beads. Typically, the beads are coated with a chemical substance designed to interact with the sample components and enhance separation. Most frequently, the beads — described earlier as the **stationary phase**, because they don’t move in the system — are very small diameter silica particles and typically have octadecylsilane (C18) chemically bonded to their surfaces. Other, more specialized materials are sometimes

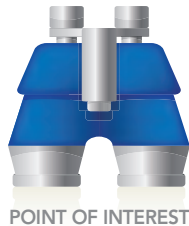

used instead of silica. Also, in addition to the C18 bonded to the surfaces of the beads, other, more specialized molecules can be bonded to the base material to further enhance the separation achieved in the column.

**Detector:** The detector is responsible for “seeing” the sample components that are separated in the column as they are being carried along by the mobile phase. The most commonly-used detector passes a beam of ultra-violet light through a special window (known as the “**flow cell**”). As the sample components pass through the flow cell, the amount of light transmitting through the flow cell changes. The electronics of the detector then convert the change in transmitted light intensity into a signal.

Other detector options are being used more frequently as the cost of technology continues to drop. Detectors such as mass spectrometers (MS) and nuclear magnetic resonance (NMR) detectors are finding increased use in many laboratories. With improved detection options now available to the chromatographer, HPLC — already a mainstay in many laboratories — is finding increasing use as an analytical technique.

# All About Fittings

**FIGURE 12** Example Chromatogram

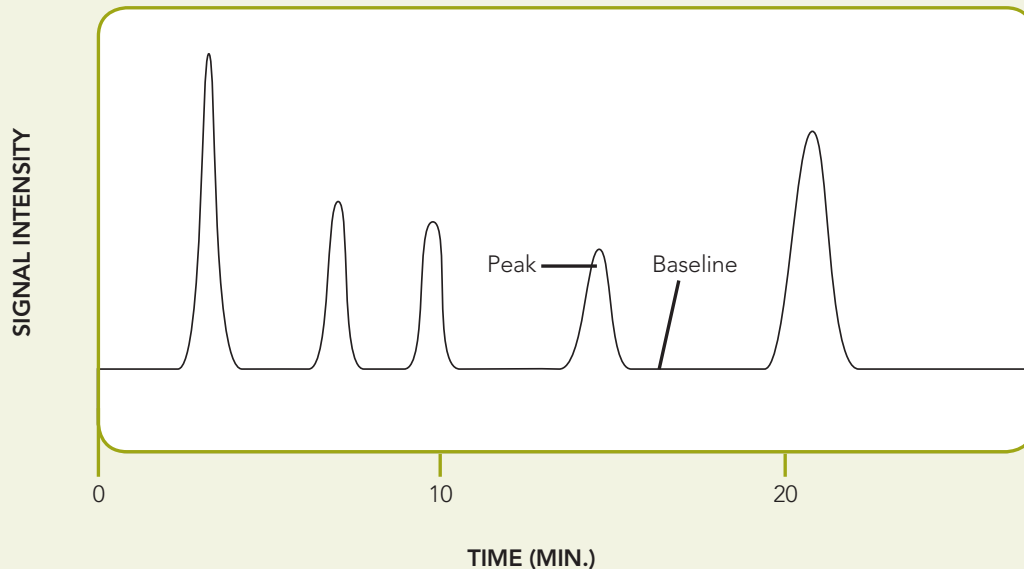

**Recorder:** The recorder translates the signal generated by the detector into a plot, creating a **chromatogram** (see the diagram of signal versus time above.)

In the early days, this device was nothing more than a strip chart recorder with a pen that moved in response to the signal created by the detector, writing on a piece of graph paper moving at a controlled speed. Then, the peaks would be carefully cut out and the paper weighed (yes...weighed) on

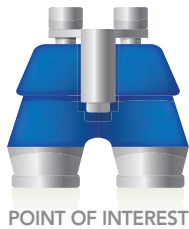

a scale to obtain semi-quantitative data. Nowadays, the recording device is usually a computer, equipped with software designed to not only translate the signal from the detector, but to also process the data digitally. This allows much more reproducible information to be generated and has facilitated the use of smaller and smaller samples.

**Waste reservoir:** The last component in a basic HPLC system, the waste reservoir safely collects all the mobile phase and sample components after they pass through the system.

# What is HPLC?

## Looking At The Components As A System

**FIGURE 13** Typical HPLC System

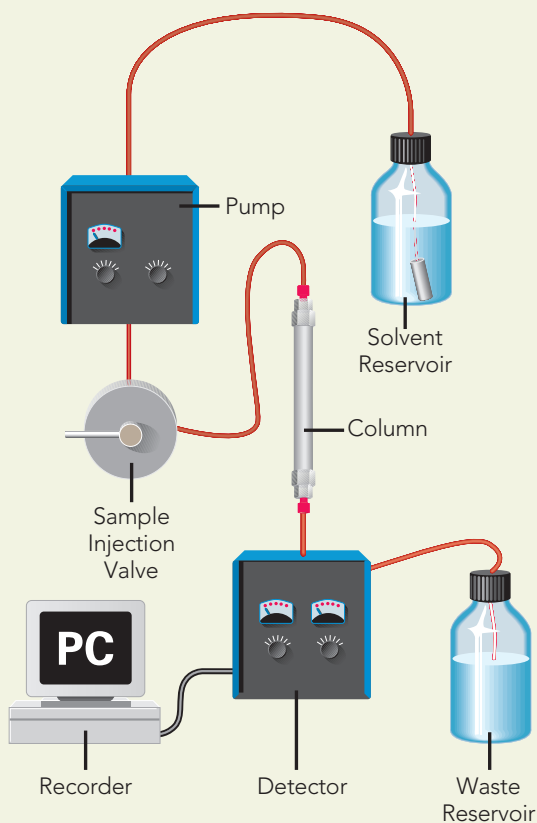

Now that you understand the basics of the key HPLC system components, let's run through the whole process again. Once a mobile phase is prepared, the pump then moves it through the system, where it encounters the sample and carries it through the column. Inside the column, the sample components selectively interact with the mobile phase and the stationary phase, separating into groups of like molecules as they move through the column. Leaving the column, the sample component groups then pass through the detector, which "sees" the components and sends a signal to the recording device, which in turn collects and processes the data. The waste reservoir then collects the fluid for disposal.

# All About Fittings

## Other system “stuff”

While an HPLC system cannot function without the basic seven components, it most certainly can function with more than those seven. In fact, there are many commonly-used accessories and components which help enhance the performance of a standard HPLC system, including the following:



KEY CONCEPT

**Filters:** Found in the solvent reservoir and along the flow path in numerous locations, filters play a vital role in maintaining system performance. Filters prevent solid particles from passing through the system; failure to use filters can result in damaged system components, increased down time, and poor chromatographic results. (For more information on filters, check out the Appendix, beginning on page 54.)

**Guard columns:** Guard columns do exactly what their name implies...they guard the main analytical column. They are typically small versions of the analytical column, used to trap sample components that would otherwise irreversibly bind to the inside of the analytical column. The guard column acts like an insurance policy for the primary analytical column, helping to delay the often-costly replacement of the primary column.

**Back pressure regulators:** A back pressure regulator (BPR) is most often placed inline between the detector and the waste reservoir. It creates

additional upstream pressure, to prevent any gases which might be dissolved in solution from outgassing and creating bubbles along the mobile phase flow path. (If any bubbles pass through the detector's flow cell, a phenomenon known as “noise” can show up on the chromatogram's baseline and limit the sensitivity of analysis.) (For more information on BPRs, see the Appendix, page 57.)

**Vacuum degassers:** A vacuum degasser is a piece of equipment that is commonly placed inline between the solvent reservoir(s) and the pump. This device is engineered to extract the dissolved gas from the mobile phase before it reaches the pump. By doing so, it helps keep the gas concentration in solution sufficiently low such that bubbles cannot form once the mobile phase transitions from the high pressure of the column to the low pressure zone post-column. As with back pressure regulators, preventing bubbles from forming helps prevent baseline noise and thus improves chromatographic results as well as reproducibility.

## What goes where?

Of course, fittings are standard items used to connect the components together, using tubing as the flow path bridge between components. Yet, one of the most commonly-asked questions regarding fittings is, “Where do all these fittings go in my system?” In other words, how do I know what to use where?



One common way to distinguish between fittings is by classifying them based on the pressure they can hold. This narrows the fittings choice based on where in the system they will be used.

Generally, fittings are classified as either “low pressure” or “high pressure” fittings. Correspondingly, “low pressure” most often refers to applications or areas in your system where the flow path pressures do not exceed 1,000 psi (~70 bar). “High pressure” areas can have flow path pressures that exceed 6,000 psi (~400 bar)! (Some of the differences between high pressure and low pressure fittings have already been discussed earlier in this manual.)

In an HPLC system, there are generally three pressurized zones, each with its family of fittings. The first zone exists

between the reservoir and the inlet of the pump. This is typically a low pressure zone, as the pump is pulling the mobile phase from the reservoir in this area, usually creating some negative pressure. The fittings used in this zone are generally low pressure, low-cost fittings, most often having a 1/4-28 flat-bottom geometry, and are generally for 1/8” outer diameter (OD) tubing.

The second zone in the system exists from the outlet of the pump through the injection valve and through the HPLC column. In this zone, the fluid flow is being resisted by the stationary phase inside the column, and as such, the pump experiences higher back pressures...as do the fittings.

In this second zone, fittings are generally classified as high pressure fittings and most frequently have a 10-32 coned geometry for use with 1/16” OD (or smaller) tubing. Because performance demands of the fittings are greater in this area of the system, the manufacturing costs and purchase price of the fittings are generally higher.

Lastly, in the third zone — from the tubing exiting the column through the detector and on to the waste reservoir — the system pressures are generally near ambient pressures, with slightly elevated pressures being experienced when extra components are used (like back pressure regulators,

# All About Fittings

for instance). Because the system pressure in this third zone is typically low, the fittings once again often assume a standard, 1/4-28 flat-bottom geometry, and they are typically for use with 1/16" OD tubing.

It is important to note that, even though this third zone is a lower pressure zone, many OEM ("Original Equipment Manufacturer") companies realize that most laboratories have more fittings with the 10-32 coned

geometry for 1/16" OD tubing than any other type of fitting. Therefore, the receiving ports available on equipment in this zone may require the use of "high pressure" fittings, even though the inline pressures are low.

The diagram below shows an "accessorized" HPLC system, to help you understand how a system is put together — including what fittings to put where.

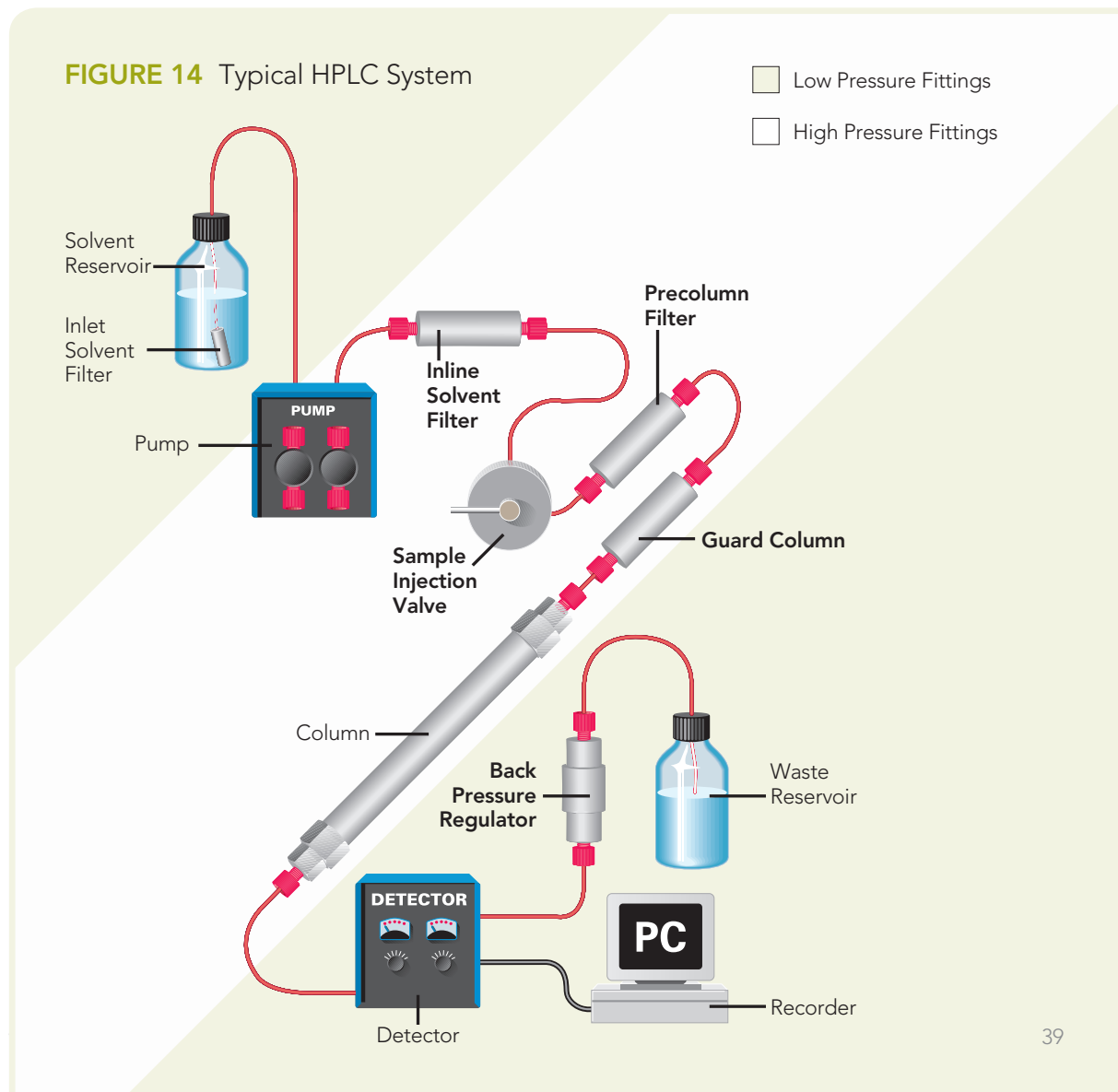

# Other Popular “Apps”

In addition to traditional HPLC, over the past several years, there have been advances in technology that have expanded the world of chromatography in several directions. Two of these have become the most prominent — microscale chromatography and UHPLC, or Ultra-High Performance Liquid Chromatography.

## Big things come in little packages

One of the most popular advances in chromatographic technology has been the development of microscale and even nanoscale chromatographic methods. Where HPLC uses things like 1/16” OD tubing, flow rates of 1 mL/min, and sample sizes of 20  $\mu$ L, this smaller-scale chromatography is known for much different “standards”: 360  $\mu$ m OD tubing, flow rates in the low microliters per minute or less, and sample sizes in the nanoliter range.

Somewhat intuitively, this smaller scale requires an increased attention to the quality of the connections that

are made, as even small dead volume chambers can have a tremendous impact on your results when operating under these conditions. Working to ensure your tubing is cut and prepared well (see page 44 for a discussion on how to properly prepare tubing) and making sure that you are using the best fittings for the application (see page 41 for a discussion on “pitfalls” to avoid when connecting capillary tubing and tips for making good connections with capillary tubing) will pay back huge dividends in the form of high quality chromatographic results.

# All About Fittings

## Making capillary tubing connections

Another important topic is the rapidly growing field of capillary tubing connections.

As analytical techniques and applications force fluid volumes lower and lower, the size of the tubing used for the flow path must also shrink to accommodate the methodology. Special guidelines are useful in selecting and using the best connectors for capillary tubing applications.

First, **capillary tubing** can be defined as any tubing with an outer diameter smaller than 1/16" OD (chosen because it is the primary size of tubing used historically with most

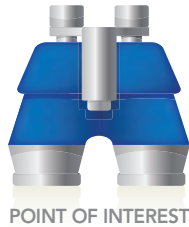

HPLC systems). As flow rates decrease, often the tubing OD and ID will also decrease in order to maintain a consistent linear velocity. Tubing sizes like 1/32" OD and 360 micrometer ( $\mu\text{m}$ ) OD are being used with increasing frequency in chromatography and related disciplines, and using these tubing sizes requires some special considerations normally unnecessary with 1/16" OD tubing. This is especially evident when using the smaller tubing in receiving ports normally designed for the larger, 1/16" OD tubing.

Frequently, analysts will attempt to adapt existing hardware (e.g. pumps, injection valves, even columns) to accommodate capillary tubing. Issues abound, however, because of the geometry and overall size of the receiving ports.

## What About...?

**FIGURE 15** Potential Dead Volume in Capillary-Based Applications

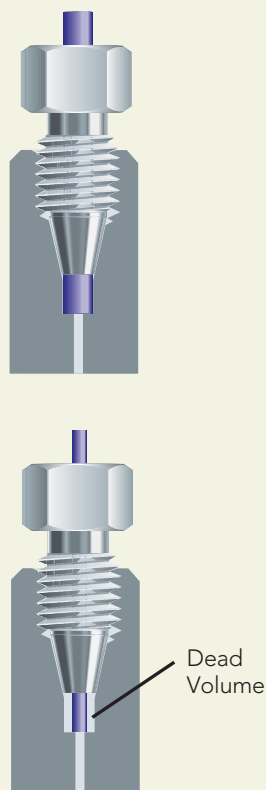

As we've mentioned, the high pressure receiving ports in most analytical-scale equipment on the market have an internal geometry supporting 1/16" OD tubing. This means that the port has an internal pocket into which the 1/16" OD tubing extends. As long as tubing with this same diameter is used, then potential dead volume resulting from the connection is kept to a minimum. However, when the tubing you're using is smaller than what the receiving port is expecting, it's easy for dead volume to be introduced in the connection...which, with capillary-based applications, can be extremely detrimental (see Figure 15).

Numerous ways have been developed to adapt smaller, capillary tubing into the receiving ports meant for larger OD tubing. Of the options available, two stand out as the most popular.

The first option involves customized ferrules which look similar to those used for the larger tubing, but which feature smaller holes drilled through them to better accommodate the capillary tubing. Additionally, most ferrules used for this purpose also offer a fixed-length nose extending beyond the tapered portion of the ferrule to reduce dead volume in the connection. Ferrule systems such as these generally hold the tubing well and have a long usable lifetime. However, there are drawbacks to consider.

**FIGURE 16**  
Example of a Customized Ferrule

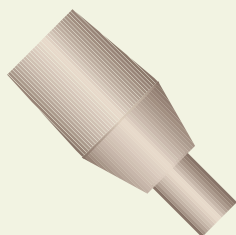

# All About Fittings

First, custom-drilled ferrules are “economically-challenged.” (In other words, they can be pretty pricey.) These items are generally manufactured from expensive materials and are typically machined versus injection molded...both of which drive up the cost.

Second, and more importantly, their fixed geometries limit where they can be used. As most ports have internal geometries that vary from one to another, using ferrules with fixed geometries can either prevent the ferrule from sealing properly or leave empty pockets in the receiving port where mobile phase and/or sample may collect. These dead volume pockets can lead to poor chromatography, including issues with carryover, split peaks, and band broadening. And with such small sample sizes and flow rates being used in capillary-based applications, dead volume pockets play a much larger role in the quality of the results.

Fortunately, the second option — the use of a special tubing sleeve — overcomes both of the primary disadvantages exhibited by the customized ferrules.

Tubing sleeves generally have a controlled outer diameter (usually 1/16”) which allows them to fit into standard threaded ports. And, since the sleeve will slide through a ferrule

until it bottoms out in a receiving port, the tubing pocket beyond the ferrule will be completely filled to help avoid dead volume in the connection.

Tubing sleeves also offer several side benefits. One is the structural support sleeves provide to the outside of the capillary tubing, helping prevent damage to the tubing as it leaves the fitting. Also, because the tubing sleeves come from extruded material, the



KEY CONCEPT

FIGURE 17

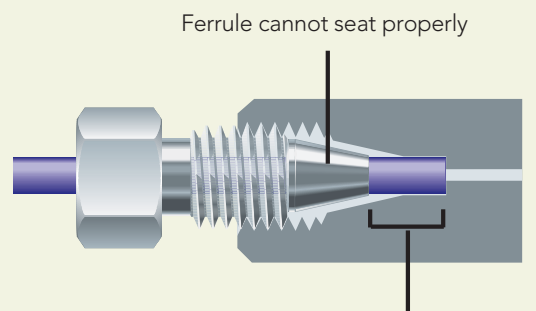

If Dimension X is too long, leaks will occur

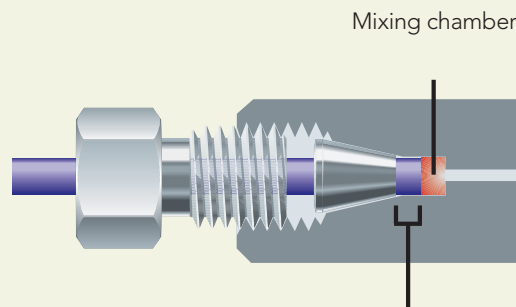

If Dimension X is too short, a dead-volume, or mixing chamber, will occur

## What About...?

sleeves can be offered in a variety of materials. Furthermore, the extrusion process generally allows a more concentric connection than precision drilling and machining can provide, offering a more accurate tubing-to-thru-hole alignment and decreasing inline turbulence and mixing, all at a reduced cost.

For all these reasons, using a tubing sleeve to connect capillary tubing into a receiving port is the method of preference — unless the receiving port is specifically designed for use with the size of tubing you are using!



But what about instances where there isn't even enough room for a threaded port to exist, such as

Lab-on-a-Chip methods? Many people using techniques like this are forced to glue their tubing in place in lieu of using a fitting for the connection. This causes a number of problems, including a weak hold on the tubing and interaction between the sample being analyzed and the glue (often epoxy) securing the tubing in place.

One available solution to this problem involves bonding a threaded port directly to the substrate's surface. By doing this, and by isolating the adhesive away from the mobile phase or the sample, you can make a reliable connection with your tubing using a traditional fitting rather than epoxy. Products, such as IDEX Health & Science's NanoPorts™, were developed specifically for this task.

## Cutting fused silica and polymer capillary tubing

Besides connecting the tubing with the proper fittings, other issues should be considered to ensure good connections and good chromatography when you use capillary tubing.

One of the major issues centers on how well you cut the tubing. Depending on the type of capillary tubing and the cutting tool used, the effect can be dramatic.

Let's take fused silica capillary tubing as a first example. One of the most popular methods for cutting this tubing employs a ceramic scoring stone. This "tool" is really just a piece of sharp-edged ceramic that scores the surface of the fused silica tubing. This allows the tubing to be pulled apart easily at the score mark.

In theory, this will allow for reasonable cut quality. However, in practice, the

# All About Fittings

results are usually different. Often, as the ceramic stone is pulled across the tubing, the polymer coating is shredded and the fused silica underneath the polymer coating is shattered under the force of the blade. Initially, you may think the tubing looks acceptable; however, once in use, the coating material or pieces of the fused silica tubing can break off and clog important internal passageways. Also, with damaged ends on the tubing, using standard compression fittings to hold that tubing in place can cause the tubing to completely shatter and result in a leak, a clogged system component, or a combination of the two.

It is almost always a better idea to circumscribe the tubing you are cutting, going all the way around the circumference



KEY CONCEPT

of the tubing, if you want to achieve a good, reproducible, quality cut on fused silica tubing. While the tools available for making this type of cut are fairly expensive, the results (and lack of a daily headache!) usually far outweigh the cost of the cutter. And, these tools are fairly easy to use.

Interestingly, the concept of circumscribing the tubing applies to polymer capillary tubing as well...but for different reasons. Often, when polymer capillary tubing is used, the inner diameters are very small — as low as 0.001" (25  $\mu\text{m}$ ) in some cases! With

inner diameters this small, it is vital to keep the thru-hole in the tubing open and centered with the passageway in the receiving port to avoid over pressurizing the connection. That's where accurate cutting comes into play.

If you cut the tubing by simply slicing it with a blade, the force of the blade pushing through the plastic will frequently cause the inner diameter to shift off center or collapse. While cutting this way won't technically cause damage to polymer tubing like it would to fused silica tubing, it can render it near-useless, depending on the degree of inner diameter shift. To avoid this risk, it is best to cut the polymer capillary tubing all the way around its circumference as well.



Again, the tools to do this are available, and they are a bit expensive; however, as with the tools for properly cutting fused silica tubing, benefits far outweigh the costs.

**FIGURE 19** Cut Polymer Tubing

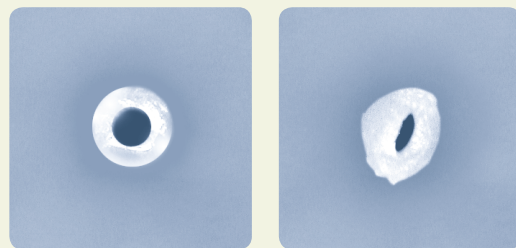

Properly Cut Tubing

Improperly Cut Tubing

### Putting the big squeeze on

Another popular chromatographic development has been the introduction of UHPLC. In a trend that started in 2004, numerous manufacturers have introduced equipment and various hardware and accessories that are suitable for use in UHPLC applications.

One of the key features of UHPLC is that the equipment runs at very high pressures. The most common systems run at pressures at or near

15,000 psi (~1,034 bar) — and some equipment even surpasses that limit! Of course, with system pressures this high, that puts even more strain on the connections in the system -- especially in the “high pressure” zone, where the system pressures are the greatest. Because of the pressure involved in UHPLC, there are certain problems that can occur in UHPLC if the fitting and tubing connections are not as good as they should be:

#### 1) Tubing Slippage

If a poor connection has been made that allows the flow path tubing to move, there are parts of the UHPLC fluid pathway that undergo a tremendous amount of stress — for example, the fittings that connect the sample loop to the injection valve. It's often in these high-stress areas that tubing connections will fail if the connections are poorly made. With tubing slippage, the problem

doesn't appear in the form of an immediate leak — it's a “slow riser,” a problem that gradually appears. While a leak won't necessarily result right away, you will likely notice your chromatographic results deteriorating due to the large dead volume chamber being created at the end of the flow path tubing as the tubing slowly slips past the grip of the fitting.

# All About Fittings

## 2) Ferrule-Related Struggles

With the high pressures involved in UHPLC applications, it's become commonplace for stainless steel fittings to be used once again. However, with the use of these types of fittings comes the problems associated with these types of fittings.

One of those problems is the amount of compression on the wall of the tubing that occurs when a metallic fitting is used. Depending upon the tightening torque applied to the connection, it's very possible for the ferrule to compress the tubing wall so much that the inner diameter is compressed as well. This inner compression creates a fluid pathway restriction that can result in a throttling effect of the mobile phase and increased mixing.

A second problem can result from the over-tightening of a metallic ferrule into a metallic receiving port. Because of the forces involved, it is possible for the ferrule to begin shearing some metal from the internal receiving port surface. This results in a damaged port that can leak and can be difficult to repair.

Another problem that can result from the over-tightening and improper use of stainless steel fittings is the impact they can make on the quality of the surface of the receiving port. Not only can galling result, but the receiving port can be deformed due to the forces applied by the ferrule. This can create a "ridge" along the inner surface that can prevent subsequent ferrules from sealing correctly.

## 3) Personal Injury

As strange as it may seem, it is possible to be injured due to improperly-made connections. Specifically, if a tubing connection suddenly fails and the fluid pressures were up to UHPLC pressures

and beyond, that sudden release of energized fluid can damage skin and soft tissues. Wearing protective gear and exercising caution will help avoid unnecessary injury.

*Because of these sources of problems in UHPLC applications, it is vital that you invest the time, effort, and resources to ensure you have made good connections throughout your system. Working with the right fittings and tightening using the proper methodology will prove invaluable as you seek to make good connections in your equipment.*

### But I still have some questions!

Because of the relative young age of UHPLC as a commercialized technique, there are some fairly common questions pertaining to making good connections that are asked. We'll pause to address some of the most popular ones:

#### **I like using Fingertight fittings for my HPLC connections – can I still use them for UHPLC connections?**

Generally speaking, because of the very high system pressures present in most UHPLC applications, standard Fingertight fittings will not typically work. Making good connections in UHPLC applications will usually require either traditional stainless steel fittings or specialized fittings that have been engineered to work in the very high pressure environment of UHPLC.

#### **Can I use polymer tubing (e.g., tubing manufactured from PEEK™ polymer) in UHPLC applications?**

Most sizes of PEEK tubing (and tubing from other polymer materials) have pressure limits that are well below the typical operating pressures of UHPLC. As such, the most popularly used tubing in UHPLC is manufactured from stainless steel. Other specialized tubing may also work; the key is to double-check with the tubing manufacturer / supplier to ensure it is rated for use at the pressures you will encounter in your UHPLC system.

#### **Do I need special fittings throughout my UHPLC system?**

This is more tricky, because most UHPLC systems are only different in the high pressure zone (see earlier discussion on page 46 for more information about the different connection zones). That means, while you will likely need to use different fittings in the high pressure zone when transitioning to UHPLC, in the lower pressure zones the connections will likely be very similar to those used in traditional HPLC."

# All About Fittings

## A Few Extra Tips

Here are a few additional useful “hints” for making great connections.

### How do I adapt?

With the long list of manufacturers creating equipment, and with all the different variations on tubing size and threaded port configuration, scientists will frequently need to find adapters to make a special tubing connection.



KEY CONCEPT

### Or will they?

Ironically, while many people might approach making a connection with an adapter, frequently adapters are unnecessary. To better understand this, let’s distinguish between adapters and their counterparts – unions.

Basically, adapters “adapt” between two different types of thread/port configurations, while unions have the same thread/port configuration on both sides.

To illustrate this point, Figure 18 shows various connectors and classifies them as either adapters or unions.

Before continuing, it’s important to establish one general “rule of thumb”:

Unions are typically less expensive than adapters while often performing equally as well. Therefore, wouldn’t it make sense to use a union wherever possible?



SECRET REVEALED

**FIGURE 18** Adapters vs. Unions

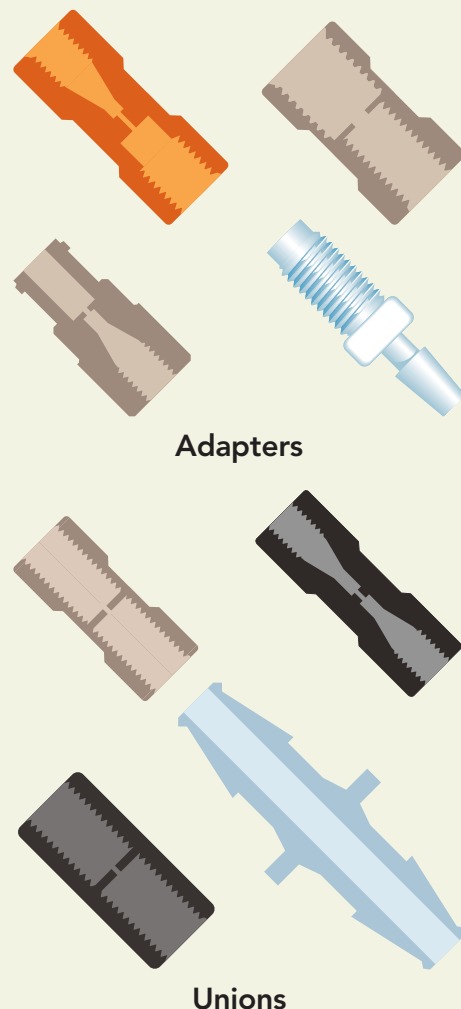

## How Do I?

The real question to consider is this:

### How do you know when you can use a union?

First, examine the connection and determine if it will be low pressure or high pressure. Sometimes this may not be so obvious, but you can often make some assumptions.

For instance, if you want to connect 1/16" OD PEEK™ tubing to a piece of 1/8" OD FEP or PFA tubing, then it would be safe to say you are making a low pressure connection. In fact, it doesn't really matter what pressure the PEEK tubing will hold — the connection is limited by the amount of pressure the softer tubing can handle.

Once you know the pressure classification for the connection you need, find out what's available in that classification from your fittings supplier. (For example, for low pressure connections, a number of low pressure unions with 1/4-28 internal flat-bottom geometry on both sides are available. You'll also find available other options with matching M6 and 5/16-24 internal threads.)

With this information in hand, all you need to do is find fittings that work with your tubing sizes that also mate with opposite sides of an available union. If such fittings exist, you can use a union to connect them — even if your tubing outer diameters are different!

Let's continue with the previous example: a low pressure connection between 1/16" and 1/8" OD tubing.

Most people trying to make this connection would instinctively look for an adapter. Of course, many suppliers manufacture adapters that can be used for that purpose. However, there are suppliers who also carry 1/4-28 flat-bottom fittings for both 1/16" OD and 1/8" OD tubing.



*This means an inexpensive union can be used, even with different tubing sizes, without compromising performance.*

Of course, there are still a number of cases where only an adapter will do. However, it is often worth the effort of looking through available products to determine if a union will work for your needs.

# All About Fittings

## What's the big ID?

Another problem you might face is choosing the right inner diameter for your applications. Because applications involving capillary tubing typically feature low flow rates and incredibly small amounts of sample, there is a general push to reduce the inner diameter to the smallest possible size. While these miniscule pathways allow the fluid to travel as fast as possible from point A to point B, one thing often overlooked is the back pressure along the tubing pathway. This is important because if system pressures become too high

where polymer fittings are used, the tubing may pop free from the fitting's friction hold, causing a leak and other undesirable consequences (e.g., system shut-down, sample loss). While many factors can contribute to system pressure, the ID of the tubing often has the greatest impact.

Please refer to the "Speaking of Pressure" section on page 58 in the Appendix for a useful formula that allows you to calculate expected back pressure in your fluid pathway.

## Void, dead and swept...an interesting concept

Often, when making connections, people want more information on the amount of "dead volume" in the connection. However, most people who inquire about the dead volume are really wanting to know just how much internal volume exists within a connection, not how much of that internal volume is considered "dead."

### But what do these terms mean?

Specifically, three terms describe the internal volume of a product: dead volume, swept volume and void volume.

**Dead volume** is that portion of the void volume that is out of the flow path. (See Figure 20, page 52.)

**Swept volume** is that portion of the void volume in a connection directly in the fluid pathway. (Again, see Figure 20.)

**Void volume** is simply another way of describing the total internal volume. It is defined as any space within a connection into which fluid can flow.

# How Do I?

**FIGURE 20** Internal Volume Defined

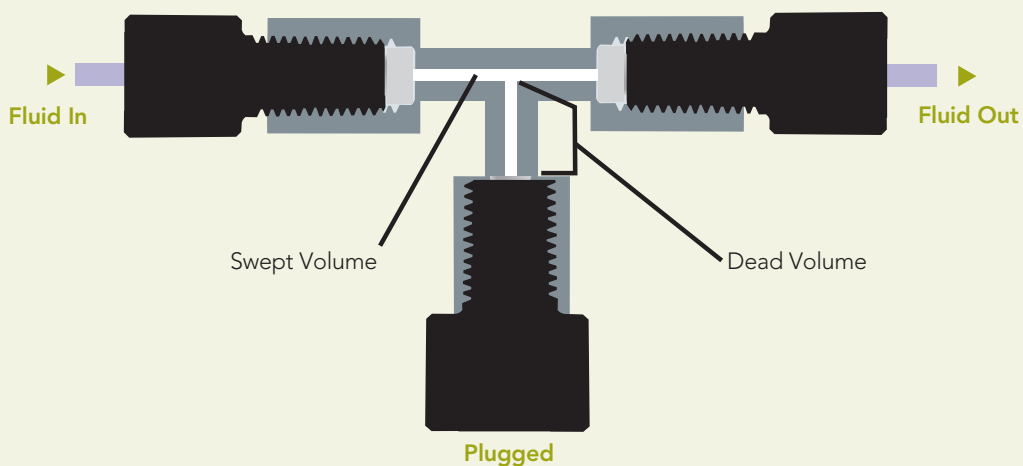

Mathematically speaking, when dead volume and swept volume are added together, the total equals the overall void volume.

$$\text{Void Volume} = \text{Dead Volume} + \text{Swept Volume}$$

Dead volume, however — particularly in capillary connections — can cause some very undesirable chromatographic effects, including:



KEY CONCEPT

- ▶ Analysis delays
- ▶ Broadened peaks
- ▶ Poor resolution
- ▶ Sample carry-over
- ▶ Split peaks
- ▶ Gas collection

# All About Fittings

If your application is not chromatography-related, dead volume can still lead to problems, including:

▶ Sample-to-sample contamination

▶ Dispensing inaccuracies

▶ Precipitation zones

In other words, no matter what your analysis technique is, dead volume will likely have a negative impact.

Therefore, in addition to keeping the volume inside the connection to a minimum, all dead volume should be removed from the connection

if possible. Ultimately, in capillary connections, the preferred relationship could be expressed as follows:

**Void Volume = Swept Volume  
(and should be REALLY small!)**

A Helpful Note: A great way to keep most of the void volume truly swept volume is to match the tubing ID as closely as possible with the diameter of the thru-holes in your equipment. This helps ensure that the fluid, once it leaves the tubing, runs completely through the entire internal passageway. This diameter matching also helps reduce the amount of turbulence the fluid experiences as it passes through the connection.

## The end of the story

While it's hard to capture all you need to know about fittings in one compact reference, it's our hope that this resource has proven to be helpful already... and will continue to be something you return to over and over again in the future.

Please feel free to contact the Customer Service staff at IDEX Health & Science if you have any further questions or if you have suggestions for future editions of this guide. Many of the improvements in this current edition are due to suggestions from interested people just like you!

# Appendix

## I know it's not a fitting, but...

While this resource is focused on fittings and making great connections, there are other useful accessories that can be used in chromatography (and related) applications. Two of the more common accessories are filters and back pressure regulators (or BPRs).

### Filters, Filters Everywhere!

"Why would I ever really need a filter?" you might ask...and you wouldn't be alone.

Many people assume their fluid pathway is clean when it often really isn't, and there are areas where using filters is very important.



Particles of all sorts can be suspended in a fluid stream. (Just because you can't see them doesn't mean they aren't there!) Things like dust, solids originating with a sample, and seal wear particles are all reasons why filters are important!

To help understand where you can consider using filters in your system, let's look at common places where filters are used in HPLC systems:

**Solvent Inlet Filters:** One of the first places where contaminants can enter a fluid stream is in the solvent reservoir itself. Whether it's biological material flourishing in solution or outside dust particles collecting in the reservoir, there are numerous ways large particles can become present in the solvent reservoir. Placing a solvent inlet filter inside the reservoir at the end of the inlet tubing will help ensure the fluid stream remains free of physical contaminants and will help protect upstream equipment.

Another useful place for an inlet solvent filter is on the end of a helium sparging delivery tube. (Sparging is a technique used to remove dissolved gas from a mobile phase.) When an inlet filter is used for sparging purposes, it does two things: it disperses the helium more effectively while also preventing particles, stemming from the gas source, from entering the mobile phase.

*For a more detailed description of the sparging process, please see "Mobile Phase Degassing — Why, When, and How" by Dr. John W. Dolan, LC-GC Volume 17 Number 10, October 1999.*

# All About Fittings

**Inline Filters:** Particles often originate from seal wear in pump and valve mechanisms, and these particles can cause blockages and equipment malfunctions if allowed to remain. Inline filters are effective “insurance policies” against such problems. Just as their name would suggest, inline filters are placed “inline”, along a fluid pathway where they can capture any particulate matter that may be traveling in the solvent stream and thus protect against blockages and equipment damage.

In addition to seal wear, in HPLC, flow path contamination can originate with the sample. To help protect against physical particulates that may be in the sample matrix, a special form of inline filter is often used, called a “precolumn filter”. Placed immediately before the column, a precolumn filter combines effective filtration protection while minimizing the possible band broadening that can sometimes occur in chromatographic applications.

Another type of contamination originating from the sample is chemical contamination, which needs to be removed using a special chemical filter called a guard column. (For more information about guard columns, see page 37.)

Fortunately, both inline and precolumn filters typically use replaceable filtration discs referred to as “frits”. Available in a variety of porosities and manufactured from several different materials, there are numerous ways to customize the filter for your specific application.

One important factor to consider when choosing the appropriate precolumn or inline filter for your application — especially if you are working with microscale or nanoscale applications — is the impact that the volume of the filter will have on the results obtained. Frits, by design, are very porous; as such, they typically contain quite a bit of volume — ranging from 18%–30%, depending upon the frits’ porosity. Because frits both increase turbulence as well as the time the sample is in contact with the mobile phase, choosing the right frit — and the right filter assembly — can be critical to obtaining good peak shape and peak resolution.

### How long will filters last?

This is one of the most frequently asked questions regarding the use of filters.

Unfortunately, there is no standard filter lifetime. You may go for months with very clean samples and mobile phase and not have to change your filters, or they may only make it a few days. It all depends on how clean your fluids are and on the condition of the seals used in your system.

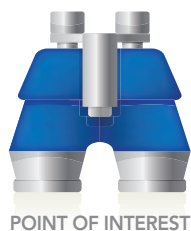

POINT OF INTEREST

A good lab practice tip is to make the replacement of your filters or frits part of your system's preventative

maintenance routine, which typically occurs every six months to one year.

There will be times when you will need to change your filter or frit in addition to the regularly-scheduled changes. But how do you know when it's time to change them? Here are some hints that may help:

► **If you notice your chromatogram peaks coming out later than normal, it may indicate that your pump isn't dispensing the right volume.** If everything on the pump appears to be functioning properly, and if there is no evidence of a leak, then the solvent inlet filter may be clogged, restricting the solvent flow to the pump.

To test this quickly, temporarily remove the solvent inlet filter from the inlet tube and re-run a few standard samples. If the analysis results return to normal, then it's likely that the pump was not getting enough fluid with the filter in place. Replace the filter with a new one, and begin your analyses again. Do not operate for long periods without a solvent inlet filter, as damage to your system may occur. (Remember this saying: "If in doubt, throw it out." Solvent filters are generally inexpensive, making it easier to be safe than sorry!)

► **If you notice the system pressure increasing, that's a good indicator that the frit inside either your inline filter or your pre-column filter may need to be changed.** As your inline filter and pre-column filter do their jobs, the frits inside will collect particles from the fluid pathway. As more particles are collected, less room is available for fluid to move through. Eventually, the pump has to "push harder" to get the same amount of fluid through, causing the system pressure to increase.

To best determine if an inline filter needs maintenance, start at the end of your system and, moving backwards toward the pump, disconnect the fluid pathway fittings one-by-one, monitoring the system pressure. Watch to see if the pressure drops suddenly; if it does, look for the restriction to be in the portion of the flow path last removed from the fluid pathway. If this happens just before a filter, replace the frit inside the filter housing. (Remember to be careful and not create a chemical spill when performing this test.)

# All About Fittings

## Regulate me!

When it comes to system pressure, inline pressure regulation is often a necessity. And that's where Back Pressure Regulators (BPRs) come into play.

A BPR is a device that creates a static inline pressure, relatively independent of the fluid flow rate or viscosity.

## But why use a BPR?

There are two main applications that call for BPRs to be used in HPLC systems.

The first application is to help prevent noise on a chromatogram's baseline. (Noise is the term applied to the erratic fluctuations on the baseline.) As fluid passes through your system, it will go through some terrific pressure changes in a short period of time. If gas is dissolved into solution, bubbles can form in the fluid pathway as the mobile phase decompresses. As these bubbles pass into the detector's flow cell, they can cause the detector's signal to change irregularly, resulting in "noise" on the baseline.

This "noise" makes it very tough to analyze small peaks on the chromatogram.

If the noise you are experiencing comes from bubbles in the flow cell,



there are two solutions: remove the gas from the mobile phase, or prevent bubbles from forming. Using BPRs won't remove the gas, but they can help prevent the bubbles from forming.

To use a BPR for this purpose, simply place it between the detector's flowcell and the waste reservoir.

When the fluid leaves the column, the BPR will help ensure the

mobile phase remains under pressure as it flows through the detector, helping to inhibit bubbles from forming. *Keep in mind your detector flow cell's pressure limit as you are selecting the correct BPR for your application.*



A BPR can also help your pump's check valves operate more efficiently. Many standard check valves are gravity-fed and rely on system back pressure to work well. If your application doesn't cause sufficient back pressure to be developed, your pump's check valves may not work correctly. However, a BPR placed immediately after the pump (but before the injection valve) often causes the pump's check valves to operate more quickly and therefore more efficiently. (Note: For most HPLC applications, it is unlikely a BPR would be needed in this location, as the typical HPLC column will create sufficient back pressure to ensure efficient check valve operation.)

## Speaking of pressure...

Sometimes it may be necessary to predict how much pressure might be created inline by your tubing. Here's a formula we have found to be very accurate (answer in psi):

$$\Delta P = \left( 9.86 \times 10^{-8} \right) \left( \frac{F L V}{d^4} \right)$$

Where:  $\Delta P$  = pressure drop in psi     $V$  = viscosity in centipoise (cp)  
 $F$  = flow rate in mL/min     $d$  = tubing inside diameter in cm  
 $L$  = tubing length in cm

## Conversion factors

Here are some other useful formulas:

|                                     |  |
|-------------------------------------|--|
| <b>Inches to Millimeters:</b>       | Inches x 25.4mm/inch   |
| <b>Inches to Centimeters:</b>       | Inches x 2.54cm/inch   |
| <b>Inches to Microns:</b>           | Inches x 25.4mm/inch x 1000 $\mu$ m/mm   |
| <b>Diameter in inches to linear</b> | ((Inches/2) x 2.54cm/in) <sup>2</sup> x volume ( $\mu$ L/inch)<br>$\pi$ x 2.54cm/inch x 1000 $\mu$ L/cm <sup>3</sup> |
| <b>Diameter in inches to linear</b> | ((Inches/2) x 2.54cm/in) <sup>2</sup> x volume ( $\mu$ L/cm)<br>$\pi$ x 1cm/cm x 1000 $\mu$ L/cm <sup>3</sup>        |
| <b>Celsius to Fahrenheit</b>        | (Celsius x 9 / 5) + 32   |
| <b>Fahrenheit to Celsius</b>        | (Fahrenheit - 32) x 5 / 9  |
| <b>psi to bar</b>                   | psi x 0.06894757   |
| <b>psi to atmospheres</b>           | psi x 0.06804596   |
| <b>psi to MPa</b>                   | psi x 0.00689476   |
| <b>psi to torr</b>                  | psi x 51.7150733   |

# All About Fittings

## Polymer information

Polymer fittings, tubing and accessories have proven to be superior to stainless steel in many analytical applications. The following performance information has been compiled for many of the polymers commonly used in analytical analyses.

**Please Note: For more information regarding the properties of the polymers listed below, please refer to [www.idex-hs.com/materials](http://www.idex-hs.com/materials).**

**Delrin®** (acetal). Delrin exhibits excellent chemical resistance to most organic solvents as well as to most neutral-pH aqueous solvents. However, it is not suitable for use with acids, bases or oxidizing agents. This polymer's high tensile strength yields superior, highly wear-resistant threads and excellent thread strength.

*Maximum operating temperatures (°C):  
Fittings 60; Tubing N/A*

**FEP** (fluorinated ethylene-propylene) and **PFA** (perfluoroalkoxy alkane). Both of these polymers are in the same family as PTFE, and as such are inert to virtually all chemicals used in HPLC. However, because of their relative softness and low durability, these polymers are generally used for low pressure applications. Choose PFA for high purity applications, or choose FEP as a general, all-purpose material. Both FEP and PFA have good thread strength.

*Maximum operating temperatures (°C):  
Fittings FEP-N/A and PFA-80; Tubing FEP-50 and PFA-80*

**Halar® ECTFE** (ethylene-chlorotrifluoroethylene). Halar is a member of the fluoropolymer family. It offers excellent chemical resistance coupled with a mechanical strength superior to many other fluoropolymers. Halar also outperforms PTFE and similar fluoropolymers in ability to withstand radiation, making it an attractive alternative for medical applications. Its exceptionally smooth surface enhances optical clarity while also helping prevent the shedding of microparticles into the fluid stream.

*Maximum operating temperatures (°C):  
Fittings N/A; Tubing 50*

**PCTFE** (polychloro-trifluoroethylene). PCTFE has excellent chemical resistance. In general, only THF and a few halogenated solvents will react with it. This resilient fluoropolymer is ideal for fittings and sealing surfaces and also has good thread strength.

*Maximum operating temperatures (°C):  
Fittings 80; Tubing N/A*

**PEEK™** (polyetheretherketone). PEEK polymer is the flagship member of the poly(aryl)ether ketone family of polymers. It has excellent chemical resistance to virtually all commonly used solvents. However, the following solvents are usually not recommended for use with PEEK: nitric acid; sulfuric acid; halogenated acids, such as hydrofluoric acid and hydrobromic acid (hydrochloric acid is approved for use in most applications); and pure halogenated gases. Additionally, due to a swelling effect, be cautious in using the following solvents with PEEK tubing: methylene chloride, THF, and DMSO in any concentration and acetonitrile in higher concentrations. Excellent thread strength.

*Maximum operating temperatures (°C):  
Fittings 125; Tubing 100*

**Polypropylene** Polypropylene is a relatively soft polymer commonly used in low pressure applications, and is especially prevalent in IVD and similar equipment. Polypropylene is excellent for aqueous solutions; however, it should not be used with chlorinated, aromatic, and some organic solvents. Fair thread strength.

*Maximum operating temperatures (°C):  
Fittings 40; Tubing 40*

## Appendix

**PPS** (polyphenylene sulfide). PPS is a resilient polymer known for its high tensile strength and excellent chemical resistance. PPS may be safely used at room temperature with most organic solvents and neutral-to-high pH aqueous solvents. However, it is not recommended for use with chlorinated solvents, inorganic acids, or any solvent at elevated temperatures.

*Maximum operating temperatures (°C):  
Fittings 50; Tubing N/A*

**Radel®** (polyphenylsulphone). Radel is an amorphous thermopolymer that is mechanically strong and offers good chemical resistance. This polymer withstands repeated autoclave sterilization cycles without suffering thermal breakdown. This property, coupled with its optical clarity, makes Radel tubing an excellent choice for medical and other applications where visual monitoring is essential. Radel is also a readily wetted material, minimizing air bubble accumulation on the inner walls of tubing manufactured with this polymer.

*Maximum operating temperatures (°C):  
Fittings N/A; Tubing 100*

**ETFE** (ethylene-tetrafluoroethylene). As a member of the fluoropolymer family, ETFE has excellent solvent resistance. Its physical properties make it ideal for demanding sealing applications. While most commonly used solvents do not interact with ETFE, take caution when using some chlorinated chemicals. ETFE has good thread strength.

*Maximum operating temperatures (°C):  
Fittings 80; Tubing 80*

**UHMWPE** (ultra-high molecular weight polyethylene). UHMWPE is a well-known and durable manufacturing polymer. Its physical properties make it ideal for general, aqueous-based environments. Take caution when using this polymer in heavily organic-based applications. Good thread strength.

*Maximum operating temperatures (°C):  
Fittings 50; Tubing N/A*

**Ultem® PEI** (polyetherimide). An amorphous thermoplastic offering high heat resistance, high strength and broad chemical resistance. Tubing made from Ultem offers a high degree of transparency. This polymer withstands various sterilization methods, such as repeated autoclaving as well as gamma radiation, ethylene oxide gas and dry heat. Ultem meets the criteria for ISO10993, FDA and USP Class VI certification.

*Maximum operating temperatures (°C):  
Fittings N/A; Tubing 125*

**Vespel®** (polyimide). Vespel thermoplastic offers high heat resistance, high mechanical strength and broad chemical resistance in most common liquid chromatography applications. However, it is particularly susceptible to attack by high pH chemical environments. Vespel can be autoclaved and sterilized using gamma radiation. Vespel offers inherent lubricity, making it ideal as a chemically resistant bearing surface.

*Maximum operating temperatures (°C):  
Sealing Components 200; Tubing N/A*

For more Polymer information, see the Chemical Compatibility chart on the next page, or download our free app at the iTunes store for instant information.

# All About Fittings

## Chemical Compatibility Chart

| Chemical Family                              | DELIRIN®         | HALAR®         | PCTFE       | PEEK <sup>†††</sup> | PERFLUOROELASTOMER | POLYPROPYLENE | PPS <sup>1</sup> | RADEL®<br>R | FEP/<br>PFA <sup>2</sup> | TEFZEL®     | UHMWPE      | ULTEM®     |
|--|------------------|----------------|-------------|---------------------|--------------------|---------------|------------------|-------------|--------------------------|-------------|-------------|------------|
| Aromatics                                    | R                | R <sup>1</sup> | R           | R                   | F                  | NR            | R                | M           | R                        | R           | NR          | R          |
| Chlorinated                                  | M                | R              | M           | M                   | M                  | NR            | M                | M           | R                        | R           | M           | M          |
| Ketones                                      | R                | R <sup>1</sup> | R           | R                   | R                  | M             | R                | M           | R                        | R           | M           | M          |
| Aldehydes                                    | R                | R <sup>1</sup> | R           | R                   | R                  | R             | R                | M           | R                        | R           | R           | M          |
| Ethers                                       | R                | M              | M           | M                   | R                  | NR            | R                | M           | R                        | R           | M           | M          |
| Amines                                       | M                | M              | R           | R                   | R                  | R             | R                | M           | R                        | M           | M           | N/A        |
| Aliphatic Solutions                          | R                | R              | R           | R                   | R                  | M             | R                | R           | R                        | R           | M           | M          |
| Organic Acids                                | NR               | R              | R           | M                   | R                  | M             | R                | R           | R                        | R           | M           | M          |
| Inorganic Acids                              | NR               | R              | R           | M                   | R                  | M             | M                | M           | R                        | M           | M           | M          |
| Bases  | NR               | R              | R           | R                   | R                  | R             | R                | R           | R                        | R           | R           | M          |
| Sulfonated Compounds                         | R                | R              | R           | M                   | R                  | M             | R                | M           | R                        | R           | M           | M          |
| <b>Thread Strength*</b>                      | <b>Excellent</b> | <b>N/A</b>     | <b>Good</b> | <b>Excellent</b>    | <b>N/A</b>         | <b>Fair</b>   | <b>Excellent</b> | <b>N/A</b>  | <b>Good</b>              | <b>Good</b> | <b>Good</b> | <b>N/A</b> |
| <b>Max. Recommended Operating Temp. (°C)</b> |                  |                |             |                     |                    |               |                  |             | FEP PFA                  |             |             |            |
| Fittings                                     | 60               | N/A            | 80          | 125**               | 200***             | 40            | 50               | N/A         | N/A                      | 80          | 50          | N/A        |
| Tubing                                       | N/A              | 50             | N/A         | 100**               | N/A                | N/A           | N/A              | 100***      | 50                       | 80          | N/A         | 125        |

1 Chemical resistance assumes room temperature use. Elevated temperatures may result in a significant reduction in chemical resistance.

2 While the chemical compatibility of FEP & PFA is virtually identical, please note the temperature limit differences.

R Recommended

M Some solvents in this category are satisfactory, others are not. In addition, maximum concentration can vary with the specific product type and chemical. Please contact Upchurch Scientific for further information.

NR Chemicals in this category are generally not recommended for use with this polymer.

N/A Information not available.

\* Shear Strength

\*\* In some cases, PEEK fittings can be used to higher temperatures. Please contact IDEX Health & Science for specific information.

\*\*\* Radel is an amorphous polymer, and as such, its upper limit service temperature is application and chemical dependent, and may be higher than 100° C in some cases.

††† Perfluoroelastomer material can be used in applications at even higher temperatures; however, its successful use is typically limited to the performance limitations of the tubing and the components used with it.

‡ In some circumstances, acetonitrile has been reported to swell and occasionally burst PEEK tubing. Exercise caution when using high concentrations of acetonitrile at or near the maximum pressure of this tubing.

### If your fittings leak

**1. Check to make sure your tubing is seated properly.** When using universal Fingertight fittings, the tubing must bottom out in the receiving port before the nut and ferrule are tightened. If a gentle tug disengages your tubing after the fittings have been tightened, loosen the nut and ferrule and try again.

**2. The fitting may not be tightened enough.** Stainless steel nuts and ferrules require a wrench to tighten them, even after repeated use. Fingertight fittings also require a good tightening torque; however, using tools incorrectly may lead to over-tightening and damage to the fitting. As such, tools should be used with caution on Fingertight fittings.

**3. You may be using incompatible fittings.** Make sure you are using a nut and ferrule that are compatible with each other and with the components

of your system. To avoid this problem and ensure compatibility, use IDEX Health & Science universal Fingertight fittings. Because the ferrule does not permanently swage onto your tubing, a Fingertight can be used repeatedly for several cycles in most systems.

**4. Check the condition of the sealing area.** After repeated use, a fitting's "sealing area" (at the tip of the fitting or ferrule), will gradually become deformed to the point of being incapable of creating a seal. As such, it is a good idea to keep an extra supply of the fittings you are using so you can replace them quickly and avoid unnecessary downtime.

**5. Check the receiving port for damage.** Sometimes a leaking connection has nothing at all to do with the nut and ferrule, but with the receiving port. Ports that have had stainless steel fittings swaged into them are especially susceptible to damage. Check the receiving port for visible burrs or scratches and replace if necessary.

**6. Evaluate chemical compatibility.** Using fittings made of material incompatible with your mobile phase is a sure way of creating leaks. Please visit the IDEX Health & Science website, [www.idex-hs.com](http://www.idex-hs.com), for more information about chemical compatibility.

#### Telltale Signs of System Leaks

Before you see the first drip of mobile phase, your system can warn you that a problem exists. The most common signs of system leaks are:

1. No flow or pressure
2. Pump pressures up, but there is no flow
3. Noisy baseline
4. Baseline drift

While all of these symptoms could also indicate problems unrelated to leaking connections, it is always easiest to start there. Not only are leaking connections usually easy to repair, they are also typically the least expensive repair option.

# All About Fittings

## Glossary

### Adapter

A union with different threads or a different geometry on each end; generally used to connect two different types of tubing together.

### Back Pressure Regulator (BPR)

A device typically used after the detector to maintain a positive pressure on the flow cell, thus minimizing solvent outgassing problems in the detector.

### Biocompatible

Refers to that special quality of some materials allowing them to come into contact with biological materials without changing the materials' bioactivity.

### Capillary Tubing

Often refers to tubing smaller than 1/16" OD; frequently used in hyphenated analytical systems, such as LC-MS.

### Check Valve

A device inserted into a moving liquid stream that allows flow of the stream in only one direction.

### Chromatogram

A graphical plot representing the change in signal intensity from a detector and often used in the numerical analysis of a sample's components.

### Column

A specialized tube, packed with small, chemically-active particles called the stationary phase, in which the separation of a sample takes place.

### Cross

An x-shaped union used to connect four pieces of tubing.

### Dead Volume

That portion of the volume within a connection that is not part of the flow path; opposite of swept volume.

### Detector

A primary analytical system component that "sees" sample components as they are being carried away from the column by the mobile phase.

### End Fitting

Used with most standard columns in the market today, it is the fitting at the end of the column that allows commonly used tubing to interface with the column tube. Additionally, the end fitting often holds the frit in place on either end of the column tube, thus retaining the packing material within the column tube.

### External Compression

Connection method utilized by most fittings systems in a majority of analytical instrumentation. It is the nearly universal connection method when rigid or semi-rigid tubing is used.

### Ferrule

A tapered conical ring used to make the seal between a piece of tubing and a receiving port. Ferrules almost invariably must be used in conjunction with a nut of some sort.

### Fingertight

A special fitting invented by Upchurch Scientific that can be tightened to normal working HPLC pressures without the use of a wrench.

### Filter

A system accessory which helps maintain overall system performance by preventing solid particles from passing along the flow path and potentially damaging sensitive components.

### Fittings

Refers to the connectors that join tubing to various components in an analysis system.

### Flanged Fitting

A fitting used in low to moderate pressure applications. The fitting requires flanging - or spreading the end of the tubing - before use. Often used with 1/4-28 or M6 threaded flat-bottom fittings.

### Flangeless Fitting

A specialized fitting designed to replace flanged fittings, where through the use of a nut and unique ferrule, a seal can be made on tubing in areas where flanged fittings were traditionally necessary.

### Guard Column

A system accessory designed to protect the main analytical column from being damaged by sample components that might irreversibly bind to the stationary phase inside.

## Glossary

### HPLC

An acronym for an analytical technique known as High Performance Liquid Chromatography, used in many laboratories around the globe.

### Injection Valve

A specialized valve used to introduce a controlled amount of sample into the mobile phase for analysis, while causing little to no system disturbance.

### Mobile Phase

Chemical solution pumped throughout an analytical system for the purpose of analyzing samples.

### Noise

Erratic signal fluctuations on a chromatogram's baseline.

### Nut

A common term used to describe the threaded portion of a fitting system.

### OEM

An acronym that stands for Original Equipment Manufacturer.

### Pump

A primary piece of an analytical system that pulls mobile phase out of the reservoir and pushes it out through the rest of the system.

### Receiving Port

Typically a threaded hole into which a fitting is attached for the purpose of holding flow path tubing in place. Low pressure ports typically have a flat-bottom geometry, and high pressure ports most often have a coned geometry.

### Recorder

A primary analytical system device that translates the signal generated by the detector into a plot of signal versus time; most often, this is usually a computer.

### Reservoir (or Solvent Reservoir)

Often a glass or plastic bottle that holds the mobile phase.

### Stainless Steel

Any variety of steel alloys designed for corrosion resistance. The different varieties - primarily 316 grade - are used to manufacture high-pressure, chemically resistant HPLC fittings and tubing.

### Stationary Phase

The small, chemically-active particles densely packed into a specialized tube known as a column and often offering an opposite chemical environment to that which is offered by the mobile phase.

### Swaging

The process of permanently attaching a ferrule (usually manufactured from stainless steel) to a piece of tubing.

### Swept Volume

That portion of the volume within a connection that is part of the flow path; opposite of "dead volume."

### Tee

A T-shaped union used to connect three pieces of tubing.

### Thread Pitch

Standardized numerical value describing how close together threads are on a fitting; English threads have a thread pitch that describes the number of threads per inch, whereas metric threads are described by the distance in millimeters between threads.

### Tubing Sleeve

A short length of tubing designed to slip over capillary tubing, allowing the capillary tubing to be successfully connected to a port designed for larger tubing.

### UHPLC

An acronym that stands for Ultra High Performance Liquid Chromatography and generally refers to chromatographic separation techniques wherein the inline pressure approaches or exceeds 15,000 psi (~1,034 bar).

### Void Volume (or Internal Volume)

The sum total of the dead volume and the swept volume in a connection.

### Waste Reservoir

The last component of a standard analytical system that safely collects the mobile phase and sample components after they have been analyzed.

## **About The Author...**

John Batts, a long-time employee with IDEX Health & Science, has extensive experience with HPLC and related techniques – as a lab technician, as an HPLC field service representative, and as a technical specialist. Driven by a passion for teaching and making difficult-to-understand concepts and material more fun and inviting, he embarked on the journey of writing — and updating — this booklet.

He currently resides with his family in the Pacific Northwest.



**IDEX Health & Science**

619 Oak Street, Oak Harbor, WA 98277 USA

Tel: +1 800 426 0191 · Fax: +1 800 359 3460 · Fax: +1 360 679 3830

E-mail: [CustomerService.hs@idexcorp.com](mailto:CustomerService.hs@idexcorp.com)

[www.idex-hs.com](http://www.idex-hs.com)